



Solar Inverter

SUNNY BOY 5000US / 6000US / 7000US / 8000US

Installation Guide



Copyright © 2009 SMA America, Inc. All rights reserved.

No part of this document may be reproduced, stored in a retrieval system, or transmitted, in any form or by any means, electronic, mechanical, photographic, magnetic or otherwise, without the prior written permission of SMA America, Inc.

SMA America makes no representations, express or implied, with respect to this documentation or any of the equipment and/or software it may describe, including (with no limitation) any implied warranties of utility, merchantability, or fitness for any particular purpose. All such warranties are expressly disclaimed. Neither SMA America nor its distributors or dealers shall be liable for any indirect, incidental, or consequential damages under any circumstances.

(The exclusion of implied warranties may not apply in all cases under some statutes, and thus the above exclusion may not apply.)

Specifications are subject to change without notice. Every attempt has been made to make this document complete, accurate and up-to-date. Readers are cautioned, however, that SMA America reserves the right to make changes without notice and shall not be responsible for any damages, including indirect, incidental or consequential damages, caused by reliance on the material presented, including, but not limited to, omissions, typographical errors, arithmetical errors or listing errors in the content material.

SMA America, Incorporated

4031 Alvis Court

Rocklin, CA 95677

Tel. +1 916 625 0870

Fax +1 916 625 0871

www.SMA-America.com

IMPORTANT SAFETY INSTRUCTIONS

SAVE THESE INSTRUCTIONS

This manual contains important instructions for Models SB 5000US, SB 6000US, SB 7000US, SB 8000US SOLAR INVERTERS, that shall be followed during installation and maintenance of the inverter.

The Sunny Boy is designed and tested according to international safety requirements, but as with all electrical and electronic equipment, certain precautions must be observed when installing and/or operating the Sunny Boy. To reduce the risk of personal injury and to ensure the safe installation and operation of the Sunny Boy, you must carefully read and follow all instructions, cautions and warnings in this Installation Guide.

Warnings

A Warning describes a hazard to equipment or personnel. It calls attention to a procedure or practice, which, if not correctly performed or adhered to, could result in damage to or destruction of part or all of the SMA equipment and/or other equipment connected to the SMA equipment or personal injury.



DANGER!

DANGER indicates a hazardous situation which, if not avoided, will result in death or serious injury.



WARNING!

WARNING indicates a hazardous situation which, if not avoided, could result in death or serious injury.



CAUTION!

CAUTION indicates a hazardous situation which, if not avoided, could result in minor or moderate injury.



NOTICE!

NOTICE indicates a situation that can result in property damage if not avoided.

Other Symbols

In addition to the safety and hazard symbols described on the previous pages, the following symbol is also used in this Installation Guide:



Information

This symbol accompanies notes that call attention to supplementary information that you should know and use to ensure optimal operation of the system.

Markings on this Product

The following symbols are used as markings on this product with the following meanings.



Warning regarding dangerous voltage

The product works with high voltages. All work on the product may only be done as described in its documentation.



Beware of hot surface

The product can become hot during operation. Avoid coming into contact with the product during operation.



Observe the operating instructions

Read the product's documentation before working on it. Follow all safety precautions and instructions as described in the documentation.



UL1741 is the standard applied by Underwriters Laboratories to the Sunny Boy to certify that it meets the requirements of the NEC and IEEE-929-2000. IEEE 929-2000 provides recommendations regarding the proper equipment and functionality necessary to ensure compatible operation when power generation is connected to the utility grid.

General Warnings



General Warnings

All electrical installations must be done in accordance with the local and National Electrical Code ANSI/NFPA 70.

The Sunny Boy contains no user-serviceable parts except for the fans on the bottom of the enclosure and the handle covers on the sides of the unit. For all repair and maintenance always return the unit to an authorized SMA Service Center.

Before installing or using the Sunny Boy, read all of the instructions, cautions, and warnings on the Sunny Boy, the PV array, in this Installation Guide.

Before connecting the Sunny Boy to the electrical utility grid, contact the local utility company. This connection must be made only by qualified personnel.

PV arrays produce electrical energy when exposed to light and thus can create an electrical shock hazard. Wiring of the PV-arrays should only be performed by qualified personnel.

Table of Contents

1	Introduction.	11
1.1	Target Group	11
1.2	Product overview	12
1.3	Safety	13
1.4	Installation Overview	15
2	Unpacking and Inspection.	16
2.1	Scope of Delivery	17
3	AC Voltage Configuration	18
3.1	Opening the Sunny Boy	18
3.2	Locating Internal Components	19
3.3	Configuring the AC Voltage	21
3.4	Utility Configuration Jumpers	24
4	Mounting.	26
4.1	Choosing a Mounting Location.	26
4.1.1	Selection of the Mounting Location.	26
4.1.2	Ambient Conditions.	27
4.1.3	Position	27
4.2	Dimensions and Required Clearances	28
4.3	Mounting Procedure	31
4.3.1	Mounting the Wall-Mounting Bracket.	31
4.3.2	Mounting the SMA DC-Disconnect (if applicable)	33
4.3.3	Mounting the Sunny Boy.	34
5	Wiring the Sunny Boy	36
5.1	Sequence of Connecting.	38
5.1.1	Wiring without SMA DC-Disconnect.	38
5.1.2	Wiring with SMA DC-Disconnect	39
5.2	Bottom View and Dimensions	40

5.3	Opening the Sunny Boy	40
5.4	Opening the SMA DC-Disconnect (if applicable).	41
5.5	Wiring the AC Output.	42
5.5.1	AC Connection Requirements	42
5.5.2	AC Wiring Without SMA DC-Disconnect	47
5.5.3	AC Wiring With SMA DC-Disconnect.	50
5.6	Wiring the DC Input	54
5.6.1	DC Connection Requirements	55
5.7	DC Input Grounding	56
5.8	Connecting the DC Wires.	57
5.8.1	DC Wiring Without SMA DC-Disconnect	58
5.8.2	DC Wiring With SMA DC-Disconnect.	60
5.8.3	DC Connection With Additional DC Distribution	65
5.9	Communication	66
5.10	Closing the Sunny Boy	66
5.11	Closing the SMA DC-Disconnect (if applicable).	68
6	Commissioning	69
7	Displays and Messages.	71
7.1	LED Operation Indicators	72
7.2	LED Fault Indicators.	74
7.3	Status Messages on the LCD Display	77
7.3.1	LCD Display Language Selection	80
7.4	Measuring Channels and Parameters.	81
7.4.1	Measuring Channels.	81
7.4.2	Operating Mode.	82
7.4.3	Sunny Boy Operating Parameters.	82
8	Troubleshooting	86
8.1	General.	86
8.2	Error Messages.	87

9	Maintenance	90
9.1	Cleaning the Fans	90
9.2	Cleaning the Handle Covers	91
9.3	Testing the Fans.	92
9.4	Exchanging the Fuses	93
9.4.1	Exchanging the GFDI Fuse within the Sunny Boy	93
9.4.2	Exchanging the PV String Fuses within the SMA DC-Disconnect.	94
10	Technical Specifications	96
10.1	FCC Compliance Information	96
10.2	Sunny Boy Wiring Diagrams	97
10.2.1	Without SMA DC-Disconnect	97
10.2.2	With SMA DC-Disconnect.	98
10.3	Specifications	99
10.3.1	Sunny Boy 5000US and Sunny Boy 6000US	99
10.3.2	Sunny Boy 7000US and Sunny Boy 8000US	100
10.3.3	SMA DC-Disconnect	102
10.4	Trip Limits / Trip Times.	103
10.5	Torque Values and Wire Sizes	104

1 Introduction

This installation guide provides all the information needed to install, commission and operate a Sunny Boy (SB 5000US, SB 6000US, SB 7000US, SB 8000US) grid-tied photovoltaic (PV) inverter.



To help avoid problems during the installation, familiarize yourself with the installation process by reading the entire Installation Guide before starting the installation.

1.1 Target Group

This manual is for qualified personnel. Qualified personnel has received training and has demonstrated skills and knowledge in the construction and operation of the device. Qualified personnel is trained to deal with the dangers and hazards involved in installing electric devices.



WARNING!

Lethal voltages are present at various points in a PV system. For safety reasons, it is recommended that only qualified personnel install and operate this equipment.

1.2 Product overview

The Sunny Boy is a DC to AC grid-tied utility interactive inverter for use with photovoltaic (PV), fuel cell, wind turbine and other sources of DC power.

In general, the Sunny Boy takes power from a DC source (PV modules) and converts it to AC power for the utility grid. This power is delivered first to local loads (household appliances, lights, motor loads, etc.), with any excess power fed to the utility. The power consumed by the local loads reduces the power needed from the utility. Excess power may actually “spin the utility meter backwards” depending on the type of meter in your system. This power may also be recorded as power credits by the utility company depending on the interconnection agreement. An example of basic system components is shown in Figure below.

Sunny Boy Installed in a Utility Interactive PV System

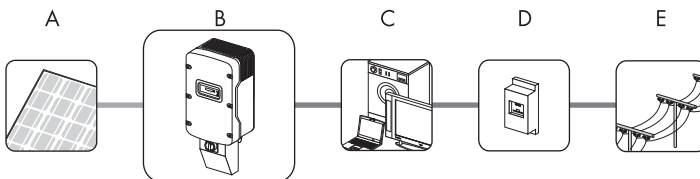

Position	Description
A	PV array
B	Sunny Boy with SMA DC-Disconnect
C	Local loads
D	Meter
E	Utility Grid



Policies vary from one utility company to another. Consult with a representative of the local utility company before designing and installing a PV system.

1.3 Safety

Anti-Islanding Protection

Islanding is a condition that can occur if the utility grid is disconnected while the Sunny Boy is operating and the remaining load is resonant at 60 Hz and matches the output of the Sunny Boy perfectly. This condition is highly unlikely and had never been witnessed outside of a controlled laboratory. Nevertheless, the Sunny Boy incorporates an advanced active islanding protection algorithm to ensure that the system will not export power into a balanced 60 Hz resonant load while the utility is disconnected. The Sunny Boy periodically injects both leading and lagging reactive current into the utility grid. This method has been proven by Underwriters Laboratories to effectively destabilize and disconnect from a balanced island condition.

PV Ground Fault Detection and Interruption

The Sunny Boy is equipped with a ground fault detection device. If a ground fault current greater than 1 Amp is detected, the Sunny Boy will shut down and display the fault condition on the user interface display. Once the ground fault is located and corrected, the ground fault error will need to be manually cleared and the inverter will then resume normal operation.

PV Series Fusing

Series fusing may be required depending on the type of PV module used in the system. See NEC 690.9

Interconnection Code Compliance

The Sunny Boy has been tested and listed by Underwriters Laboratories to meet the requirements of UL1741 Static Inverters and Charge Controllers for use in Photovoltaic Power Systems and UL1998 Software in Programmable Components, as well as IEEE-929-2000 Recommended Practice for Utility Interface of Photovoltaic Systems and IEEE 1547 Standard for Interconnecting Distributed Resources with Electric Power Systems. The Sunny Boy is also listed under UL1741 for Canadian UL.



Contact the local utility and/or the authority having jurisdiction prior to connecting the Sunny Boy to the utility grid.

FCC Compliance

The Sunny Boy has been tested and shown to conform with all FCC Part 15 A & B EMI/EMC emissions regulations.

Feature Overview

Over twenty years of inverter manufacturing experience has gone into the design of the Sunny Boy. As a result, the Sunny Boy represents state-of-the-art technology, high reliability and over all ease of use - all the qualities you've come to expect from the industry leader in inverter manufacturing. Some of the features included are:

- LCD Display
- Temperature regulated fan cooling with simplified fan replacement
- Auto line voltage detection and configuration
- Advanced communication options
- Compatible with all Sunny Boy products
- High efficiency
- Quiet operation
- Simple installation
- Powder coated die-cast enclosure

Operating Temperature

The Sunny Boy has been designed to maintain full power output at ambient temperatures as high as 113 °F. Fan cooling allows this level of output power to be achieved even in enclosed spaces. The Sunny Boy will continue to operate well beyond 113 °F and de-rates as needed to maintain a safe internal component temperature.

1.4 Installation Overview

This section provides a high-level overview of the installation process so you have an idea what to expect as you proceed through the rest of the Installation Guide.

The installation process is broken down into the following tasks:

Section 2: Unpacking and Inspection

This section provides instructions and information for unpacking the Sunny Boy and inspecting it for shipping damage.

Section 3: AC Voltage Configuration

This section includes information on removing the cover, locating primary components within the inverter and selecting the appropriate voltage configuration for the installation.

Section 4: Mounting

This section includes guidelines to help you select the best mounting location, suggestions to insure optimum performance, cautions and warnings that you should follow to avoid injury and/or equipment damage and step-by-step instructions for mounting the Sunny Boy inverter.

Section 5: Wiring the Sunny Boy

This section includes guidelines for selecting the correct wire sizes, cautions and warnings that you should follow to avoid injury and/or equipment damage and step-by-step instructions for wiring the Sunny Boy to a PV array, household electrical circuits and the utility grid. Procedures are also included for connecting optional data-communication cables.

Section 6: Commissioning

Commissioning involves applying DC input power to the Sunny Boy, observing the LED and LCD indicators on the front cover, and resolving any problems that occur.

Section 7: Displays and Messages

This section provides troubleshooting tips and procedures for resolving problems that may occur during installation and operation.

Section 8: Troubleshooting

This section provides troubleshooting tips and procedures for resolving problems that may occur during installation and operation.

Section 9: Maintenance

This section includes maintenance and cleaning of the Sunny Boy and cautions and warnings you should follow to avoid injury and/or equipment damage.

Section 10: Technical Specifications

This section includes technical data for the Sunny Boy, connection diagrams and torque specifications for the connection of cables and the screws of the Sunny Boy.

2 Unpacking and Inspection

All Sunny Boy inverters are thoroughly tested and inspected before they are packed and shipped. Although they are shipped in sturdy, recyclable packaging; damage can still occur during shipping. It is important to carefully inspect the shipping container prior to beginning the installation. If any external damage to the packaging makes you suspect the inverter itself could be damaged, or if you find that the inverter is damaged after unpacking it, report the damage immediately to your SMA dealer and to the shipping company that delivered the Sunny Boy. If it becomes necessary to return the Sunny Boy, use the original packaging in which it was delivered.

**WARNING!**

The Sunny Boy weighs up to 148 lb. (67 kg). To avoid injury, be sure to use proper lifting techniques and secure the help of someone to assist in the unpacking and installation of the inverter.

If you need assistance with a damaged Sunny Boy, contact your SMA dealer or SMA America. Contact information for SMA America is provided below.

SMA America, Incorporated
4031 Alvis Court
Rocklin, CA 95677
Tel. +1 916 625 0870
Fax +1 916 625 0871
www.SMA-America.com

2.1 Scope of Delivery

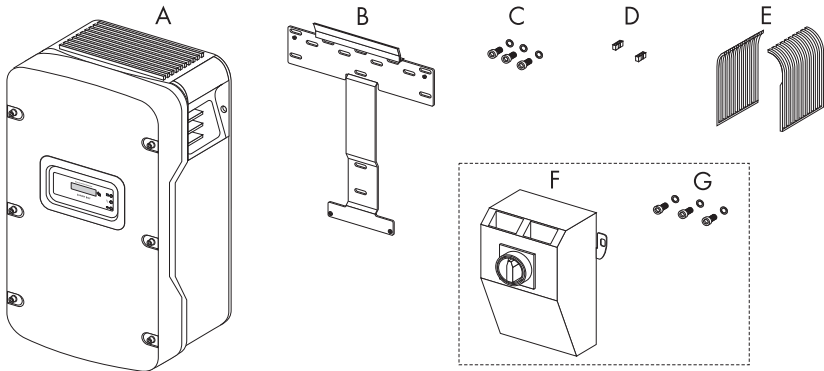

Sunny Boy:

- A one Sunny Boy
- B one wall-mounting bracket
- C one screw and washer for closing the Sunny Boy cover (spare)
two screws and two washers for fastening the Sunny Boy to the wall-mounting bracket
- D two jumpers in spare (for the fan test and for the grid configuration)
- E two handle covers (left and right)

SMA DC-Disconnect (if applicable):

- F one SMA DC-Disconnect
- G one screw and one washer for closing the SMA DC-Disconnect cover two M6 x 10 screws and two washers for fastening the SMA DC-Disconnect to the wall-mounting bracket

3 AC Voltage Configuration

3.1 Opening the Sunny Boy

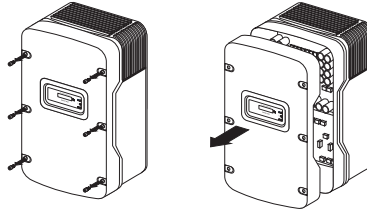

1. Remove the six screws and lock washers from the housing cover and pull the cover forward smoothly.
2. Place the cover, screws, and lock washers aside where they will be out of your way while you are connecting wires and cables to the Sunny Boy.



CAUTION!

Be careful not to misplace the screws or the lock washers, as all six screws and lock washers are required to ensure that the cover is grounded properly and is fully sealed to the case. Handle the cover carefully, as even minor damage to the cover could result in an inadequate seal between the cover and the case, thus allowing moisture to enter the case and damage the sensitive electronic components.

NOTICE!

Do not install the Sunny Boy during periods of precipitation or high humidity (>95%). Moisture trapped within the enclosure may cause corrosion and damage to the electronic components.

3.2 Locating Internal Components

The figure below illustrates the locations of the major internal components of the Sunny Boy. Refer to this illustration as needed to locate particular components.

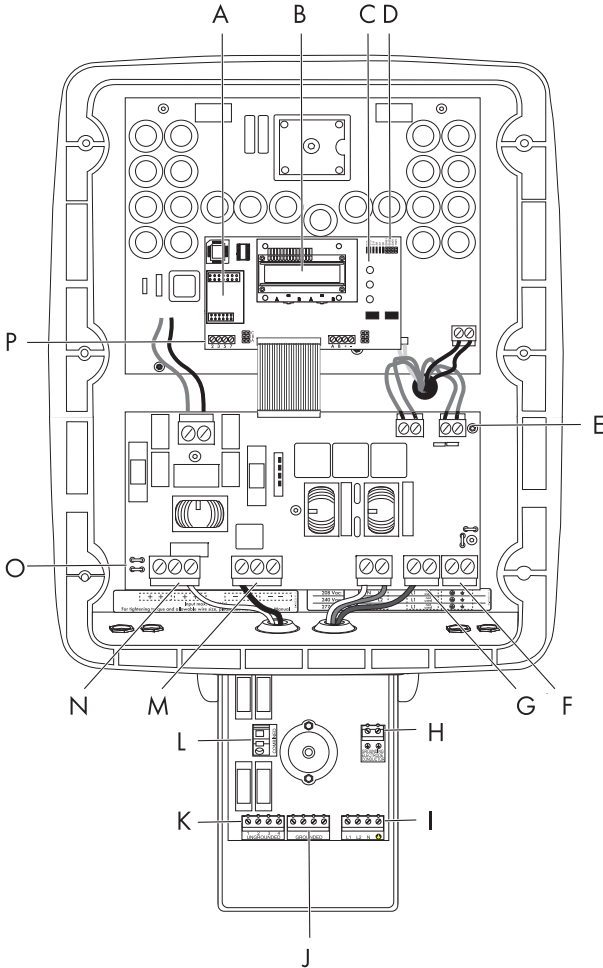

Position	Description
A	Sockets for optional communication Piggy-Back (RS485 or wireless)
B	Display
C	Status LEDs
D	Voltage Configuration Jumpers
E	Voltage Configuration Terminal Blocks

Position	Description
F	Ground Terminal (PE)
G	Output AC Line Terminals (N, L1 and L2)
H	PV Grounding + DC Grounding electrode conductor
I	Output AC Line Terminals (L1, L2, N and PE)
J	PV GROUNDED Terminal (input from PV array)
K	PV UNGROUNDED Terminal (input from PV array)
L	Combined UNGROUNDED Terminal
M	DC- Terminal (input from PV array)
N	DC+ Terminal (input from PV array)
O	Flat connection for grounding the cable shield for communication
P	Terminal for optional communication (RS485)

3.3 Configuring the AC Voltage



The Sunny Boy 8000US may not be connected to a 208 V grid.

The Sunny Boy may be easily configured for the different grid types commonly found in the U.S. The Sunny Boy is compatible with:

- 208 V AC output (except for Sunny Boy 8000US)
- 240 V AC output
- 277 V AC output

The Sunny Boy comes from the factory pre-configured for utility interconnection at 240 V AC. The Sunny Boy may be reconfigured for other voltages by following the steps below and referring to Figure to the right.

There are four wires coming into the main cabinet through a grommet. Each wire is labeled with its corresponding voltage and is connected to one of the two large terminal blocks located just below the grommet. Refer to the Figure on the right and follow the instructions below:

1. The input voltage setting is determined by the jumper that is connected to the left terminal block (A). The Sunny Boy comes from the factory configured for connection to a 240 V system. If the system is 240 V, no adjustment is necessary.
2. If adjustment is necessary, choose the wire with the correct voltage for your application from the right terminal block (C) and connect it to the left side of the left terminal block. Tighten all wires on the left terminal block.

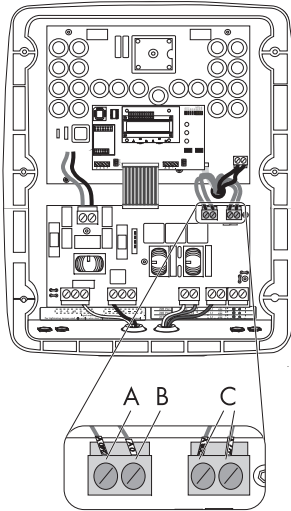

Torques for left AC configuration terminal block:

Grey Terminal Blocks (Weidmüller)	10 - 6 AWG: 18 in-lb (2 Nm)
Green Terminal Blocks (Phoenix)	8 - 6 AWG: 40 in-lb (4.5 Nm)
	10 AWG: 22 in-lb (2.5 Nm)

3. Do not remove the wire in the left terminal block labeled 0 V (B). It remains connected to the right side of the left terminal block in all configurations.
4. All unused wires connect to the right terminal block (C) and tighten them. Torques for right AC configuration terminal block (unused wires):

Grey Terminal Blocks (Weidmüller)	11 in-lb (1.2 Nm)
Green Terminal Blocks (Phoenix)	15 in-lb (1.7 Nm)

If the Sunny Boy is configured for the incorrect transformer voltage, (e.g. the inverter is configured for 240V and then connected to a 208V grid), the Sunny Boy will display the following error message:



Disturbance
XFR

If this error message is encountered, recheck the input voltage configuration and confirm that it is set properly.

Automatic Grid Voltage Detection

The Sunny Boy's software is designed to automatically detect which grid voltage it is feeding. Depending upon the voltage and phase angle between L1-N and L2-N, the inverter will determine if it is connected to a 208 V, 240 V or 277 V grid. If the Sunny Boy is configured for the incorrect transformer voltage, (e.g. the inverter is configured for 240 V and then connected to a 208 V grid), the Sunny Boy will display an error message.

The table below lists the voltage and frequency limits for the AC connection.

Voltage Range for 208 V nominal, line to line (except Sunny Boy 8000US)	183 V - 229 V
Voltage Range for 240 V nominal, line to line	211 V - 264 V
Voltage Range for 277 V nominal, line to neutral	244 V - 305 V
Frequency Range	59.3 Hz - 60.5 Hz

If the utility system has a neutral, the local Authority Having Jurisdiction (AHJ) may require that the neutral be connected to the inverter. Follow the procedure in 3.4 "Utility Configuration Jumpers" (page 24) to set the configuration jumpers and chapter 5.5.2 "AC Wiring Without SMA DC-Disconnect" (page 47) to connect a neutral conductor to the Sunny Boy.

Common Utility Voltage Configurations

The figure below illustrates commonly used transformer types. Remember, when connecting the Sunny Boy to the utility, the phase relationship is not important, but the voltage must be compatible.

480 Delta: 277 WYE

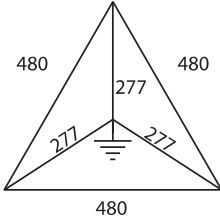

208 Delta: 120 WYE *

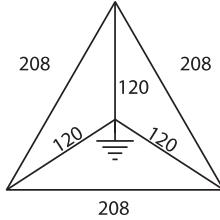

240: 120 Split Phase

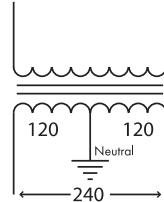

240 Delta: 120 Stinger

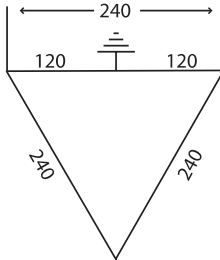

240 Delta

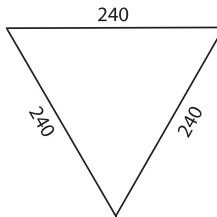

208 Delta *

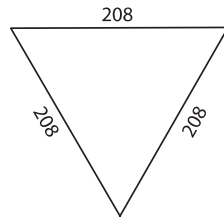

**480 Delta
DO NOT USE!**

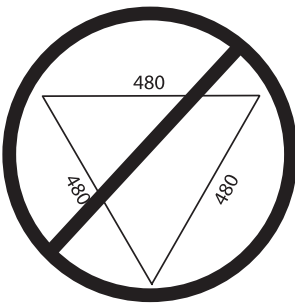

**240 Delta:
Corner grounded**

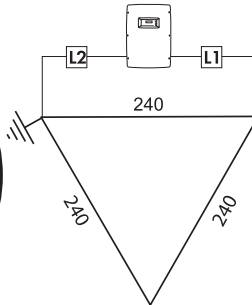

**208 Delta:
Corner grounded ***

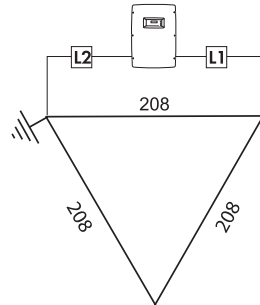

*The Sunny Boy 8000US may not be connected to a 208 V grid.



When using 240 V Delta corner grounded, or 208 V Delta corner grounded grids connect the L2 terminal to the grounded corner.

3.4 Utility Configuration Jumpers

The utility configuration jumpers allow the Sunny Boy to be connected to transformers where the neutral is not present, such as the 208 V and 240 V Delta, shown in Figure "Common Utility Voltage Configurations" on page 23. The figure below shows an overview of default settings, settings for grids with no neutral, and fan test settings.

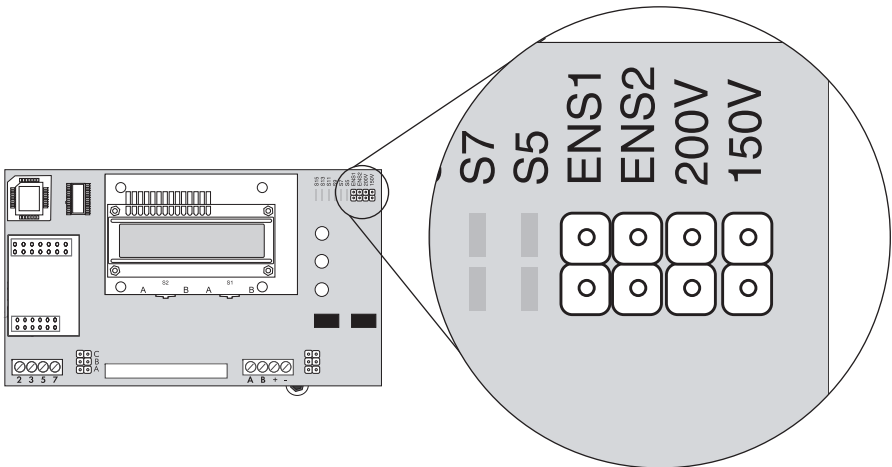

Default settings:
(use Input Voltage Wires)

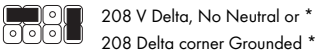

* The Sunny Boy 8000US may not be connected to a 208 V grid.

The figures below illustrate the proper jumper settings when connecting to a 240 Delta: 120V Stinger type transformer, or 240 Delta Corner grounded transformer, respectively. Note the order in which inverters are connected to the phases.

Configuration Jumper Examples for 240 V Delta: 120 V Stinger

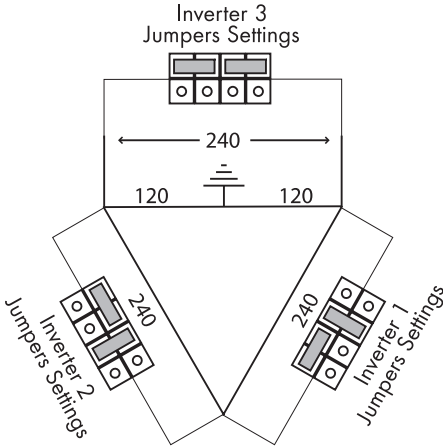

Configuration Jumper Examples for 240 V Delta corner grounded

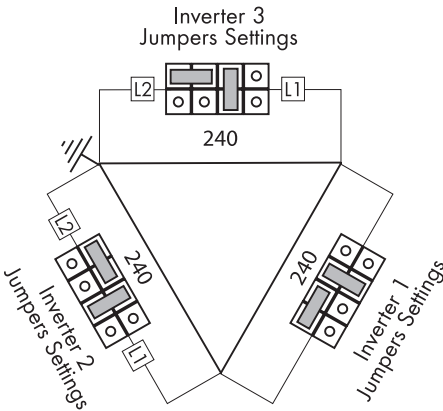

When using 240 V Delta corner grounded, or 208 V Delta corner grounded grids connect the L2 terminal to the grounded corner.

4 Mounting

This section provides guidelines to help you select the best mounting location, suggestions to insure optimum performance, cautions and warnings that you should follow to avoid injury and/or equipment damage, and step-by-step instructions for mounting a Sunny Boy inverter.



WARNING!

The Sunny Boy weighs up to 147 lb. (67 kg). To avoid injury, be sure to use proper lifting techniques and secure the help of someone to assist in the unpacking and installation of the inverter.



Occasionally, the rating label on the Sunny Boy will need to be referred to. For this reason, it is required that the inverter be mounted so that the rating label on the side of the inverter is visible.

4.1 Choosing a Mounting Location

Consider the following guidelines, cautions, and warnings when choosing a mounting location for the Sunny Boy.

4.1.1 Selection of the Mounting Location



DANGER!

Danger to life due to fire or explosion.

There is always a certain risk with electric devices that a fire can occur, even though greatest attention was paid to avoiding this during the development.

Do not install the inverter

- on flammable construction materials,
- in areas where highly flammable materials are stored,
- in potentially explosive areas!



CAUTION!

The Sunny Boy weighs up to 147 lb. (67 kg). Ensure that the mounting surface is strong enough to hold the weight of the Sunny Boy. Do not mount the Sunny Boy on plasterboard (sheet-rock) or thin wood panelling.

- The inverter should be installed in a location that is inaccessible to children.

- The Sunny Boy emits a slight vibrating noise when operating. This vibration is normal and has no effect on performance, but it can be objectionable if the inverter is mounted on a wall in a living area, on the outside of a wall that is near a living area, or on certain types of materials, such as thin wood panelling or sheet metal.

4.1.2 Ambient Conditions

- Do not install the Sunny Boy in direct sunlight. External heating from exposure to the sun may cause excessive internal heating. This can result in reduced output power to protect the internal components from damage.
- Install the Sunny Boy in a location that maintains an ambient air temperature that is less than 113 °F (45 °C). To maintain a safe internal component temperature, the Sunny Boy may power reduce if the ambient air temperature exceeds 113 °F (45 °C). (The cooler the air temperature, the longer the life expectancy of any power electronics device.)
- The Sunny Boy is constructed in a rugged powder coated aluminum enclosure designed for outdoor installations. However, care should always be taken to minimize exposure to the elements. It is best to minimize exposure to rain, snow and ice, etc. Do not install the Sunny Boy in a location exposed to sources of direct water spray such as sprinklers or downspouts.

4.1.3 Position

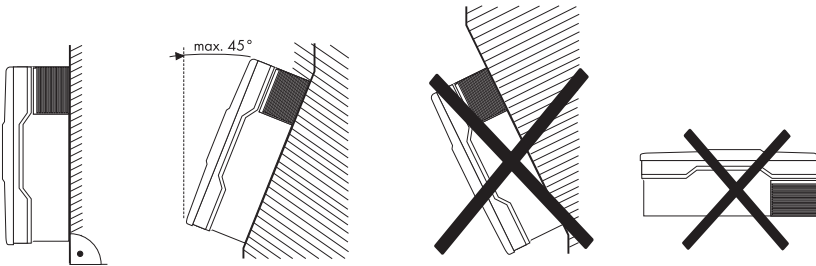

- Vertical installation or tilted backward by max. 45°.
- Never install the inverter with a forward tilt.
- Do not install horizontally.
- Install at eye level to allow operating modes to be read at all times.

4.2 Dimensions and Required Clearances



CAUTION!

If you are installing the Sunny Boy in a cabinet, closet, or other relatively small enclosed area, you must provide sufficient air circulation to dissipate the heat generated by the inverter.

The outer dimensions of the Sunny Boy are shown in the figure below. The Sunny Boy must be mounted so that there is at least eight inches of clearance around the Sunny Boy. Wall-mounted outdoor units are intended for mounting at least 3 feet of the ground.

Outer Dimensions of the Sunny Boy

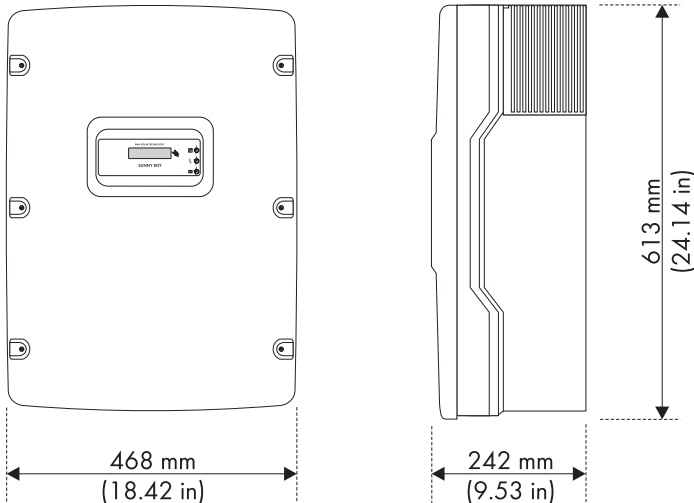

You must ensure that there is sufficient clearance for the flow of the air around the Sunny Boy! In a normal operating environment with good ventilation, eight inches of clearance is adequate.

The National Electrical Code may require significantly larger working clearances (see NEC Section 110.26).

Dimensions of the Wall Mounting Bracket

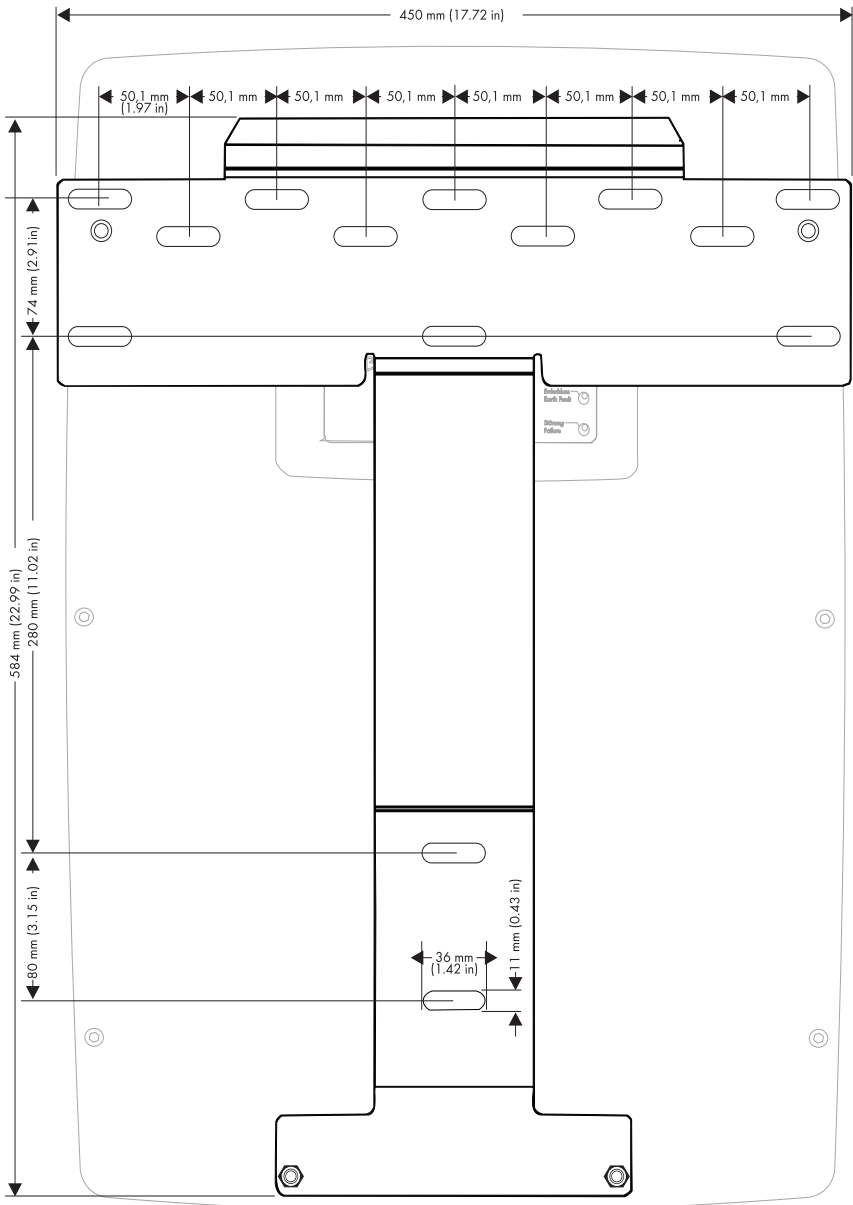

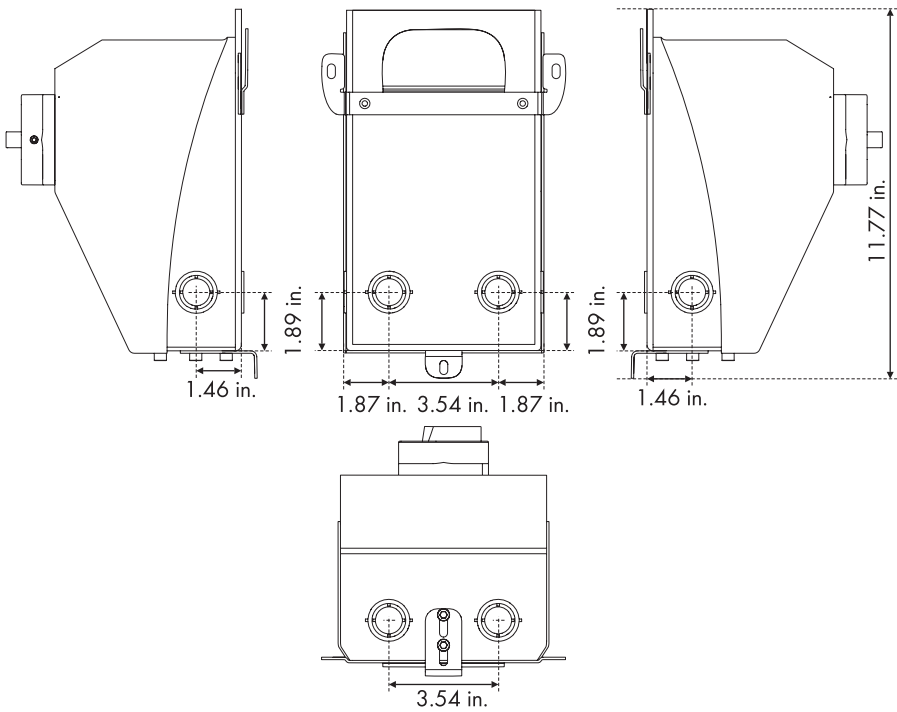
Dimensions for the installation of the conduits

4.3 Mounting Procedure

4.3.1 Mounting the Wall-Mounting Bracket

The Sunny Boy is shipped with a T-shaped wall-mounting bracket that is suitable for use with most walls (see Figures below). The horizontal part of the bracket has 12 holes. Use the 4 outermost holes of the wall-mounting bracket for mounting on wooden stud walls. Make sure that the wall you choose to mount the Sunny Boy on is sturdy enough to support its weight (67 kg/145 lb.) over a long period of time and that the wall is plumb. The bracket may also be mounted on stone, brick or solid walls. Be sure to use the appropriate type of mounting hardware for the wall material and ensure that the hardware is no smaller than 1/4".

Mounting Bracket - Stone Wall Mounting

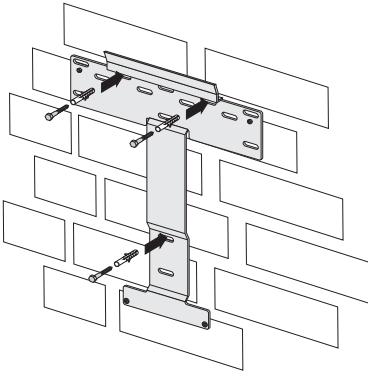

Mounting Bracket - Wood Wall Mounting with 1 Stud

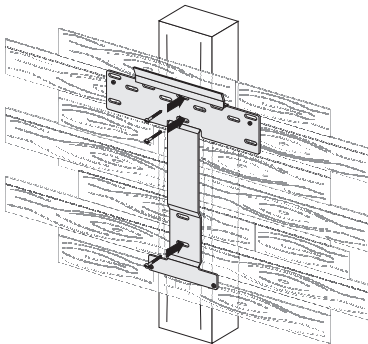

Mounting Bracket - Wood Wall Mounting with 2 Studs

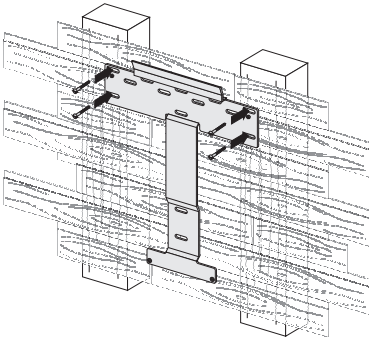

Use the following procedure to mount the wall-mounting bracket:



WARNING!

To prevent electrical shock or other injury, check for existing electrical or plumbing installations in the walls before drilling mounting holes for the Sunny Boy.

1. Locate the T-shaped wall-mounting bracket included in the shipping container with the Sunny Boy.
2. Position the wall-mounting bracket against the wall where you intend to mount the Sunny Boy. (Try to mount the Sunny Boy so that the display is approximately at eye-level.) Place a level on the top edge of the bracket, and adjust the position of the bracket until it is level. The bottom of the bracket will be the approximate location of the bottom of the inverter.
3. Using the wall-mounting bracket as a template, mark the wall through at least three holes in the horizontal or vertical portion of the bracket.



CAUTION!

Ensure that there are studs in the wall at the places where you intend to drill the mounting-holes. **DO NOT** use molly or toggle bolts to mount the Sunny Boy to sheet rock or panelling.

4. Set the bracket aside temporarily, and drill holes at the marks you made on the wall.



Tip for installing

The diameter of the holes you drill must match the hardware you are using to mount the Sunny Boy.

For example, if you are mounting the Sunny Boy to a concrete wall, the hole diameter should be approximately the same as the outside diameter of the concrete anchors you intend to use. If you are mounting the Sunny Boy on a wall that has wooden studs inside it, the hole diameter should be the correct size for the lag screws you intend to use to mount the bracket. It is recommended that the lag screws be made of stainless steel, and the diameter of the screws closely match the diameter of the holes in the wall-mounting bracket. Make sure that the screws are long enough to penetrate the wall to a depth of 1 and 1/2".

5. Insert the screws through the holes in the wall-mounting bracket and into the holes you drilled in the wall. Tighten the screws until the bracket is held firmly against the wall. Do not overtighten the screws.

4.3.2 Mounting the SMA DC-Disconnect (if applicable)

Attach the SMA DC-Disconnect to the two lower holes of the wall-mounting bracket, using two M6 x 10 screws and washers provided. The teeth of the washers should face towards the wall in order to ensure proper grounding. Tighten the screw to a torque of 44 in-lb (5 Nm).

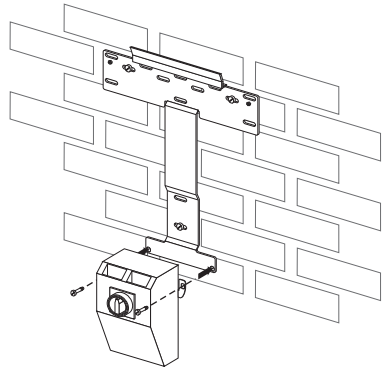

4.3.3 Mounting the Sunny Boy

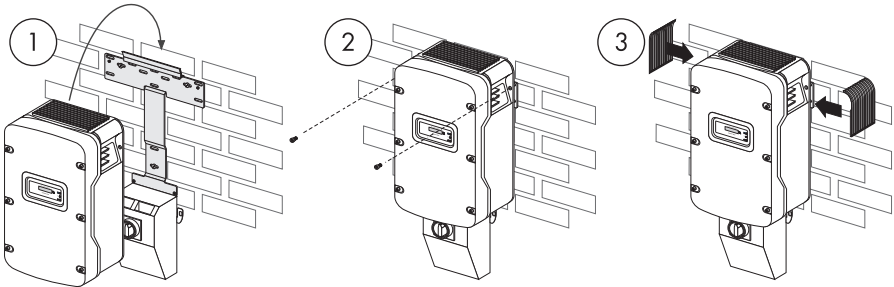

Use the following procedure to mount the Sunny Boy:

1. Carefully lift the Sunny Boy onto the wall-mounting bracket. Hook the Sunny Boy using the enclosure opening in the back plate into the wall bracket (see # 1 in Figure above).



WARNING!

The Sunny Boy weighs up to 147 lb. (67 kg). To avoid injury, be sure to use proper lifting techniques and secure the help of someone to assist in the unpacking and installation of the inverter.

2. Inspect the Sunny Boy from both sides to ensure that it sits centered on the wall bracket.
3. Attach the Sunny Boy to the mounting bracket with the two M6 screws and washers provided through holes next to the fan outputs on both sides of the Sunny Boy (see # 2 in Figure above). The teeth of the washers should face towards the wall in order to ensure proper grounding. Tighten the screws to a torque of 44 in-lb (5 Nm).
4. Close the fan outputs with the handle covers (see # 3 in Figure above) provided in the accessories kit. They are required to adequately prevent insects entering the unit.



Should the handle covers break, new handle covers can be ordered from SMA America.

5. Carefully verify that the Sunny Boy is firmly mounted in place.

6. When the Sunny Boy has been mounted correctly it should look like one of the examples in Figure below.

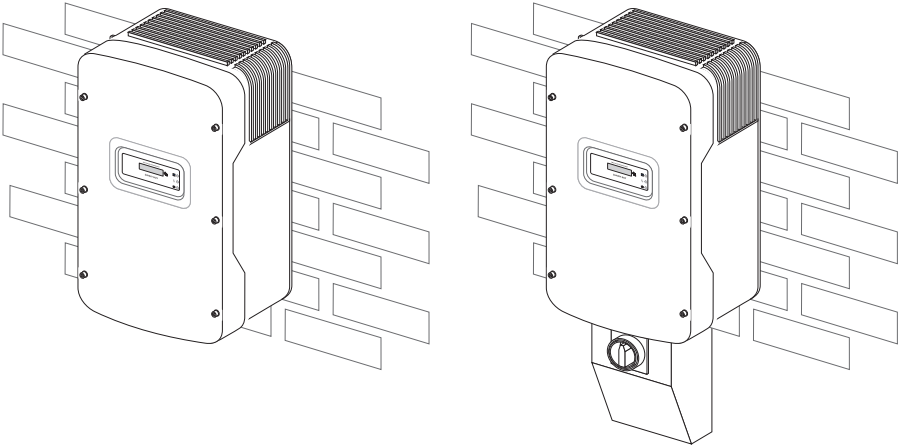

5 Wiring the Sunny Boy

This section provides step-by-step procedures and other information required for wiring the Sunny Boy to the PV array and the utility grid. To complete the installation in a safe and efficient manner, complete the steps in the order that they appear.



WARNING!

Before connecting or operating the Sunny Boy, read all of the instructions, cautions, and warnings on the Sunny Boy, the PV array and in this Installation Guide.



WARNING!

You must connect the wires that carry the AC voltage from the Sunny Boy to the utility grid and the wires that carry the DC voltage from the PV array to the Sunny Boy in the order described in the procedures in this section. Deviating from these procedures could expose you to lethal voltage that can cause serious injury.



WARNING!

Always turn OFF all breakers and switches in the PV system before connecting any wires to or disconnecting any wires from the Sunny Boy.

For inverters provided with a fixed AC output:



The AC input and AC output circuits are isolated from the enclosure and system grounding, if required by section 250 of the National Electric Code, ANSI/NFPA 70, is the responsibility of the installer.

The Photovoltaic System Grounding shall be installed per the requirements of sections 690.41 through 690.47 of the National Electric Code, ANSI/NFPA 70, and is the responsibility of the installer.

AC Grounding

The Sunny Boy must be connected to the AC ground from the utility via the Ground Terminal (PE) (see 3.2 "Locating Internal Components" (page 19)).

PV Grounding

The PV array (frame) ground should be connected to the PV Grounding and DC Grounding Electrode Conductor (see 3.2 "Locating Internal Components" (page 19)). The size for the conductor is usually based on the size of the largest conductor in the DC system.

DC Grounding Electrode Conductor

A DC grounding electrode conductor may be required by the Authority Having Jurisdiction (AHJ) Use the PV Grounding and DC Grounding Electrode Conductor (see 3.2 "Locating Internal Components" (page 19)).

5.1 Sequence of Connecting

5.1.1 Wiring without SMA DC-Disconnect



WARNING!

Always connect the wires to the Sunny Boy in the following sequence:

1. De-energize all energy sources by opening all AC and DC disconnects and/or breakers.
2. Wiring from AC breaker to the AC disconnect switch.
3. Wiring from the AC disconnect switch to the Sunny Boy, follow the procedure on page 47 et seq..
4. Wiring from the PV wires to the DC disconnect.
5. Wiring from the DC disconnect to the Sunny Boy, follow the procedure on page 58 et seq..
6. Turn the DC switches and/or breakers ON.
7. Turn the AC switches and/or breakers ON.

To disconnect the Sunny Boy first turn OFF all AC disconnects and then all DC disconnects. The AC system should always be disconnected before the DC system.

After the Sunny Boy is de-energized, disconnect the wiring in the reverse order from above.



WARNING!

Always wait a minimum of 5 minutes for stored potentials in the Sunny Boy to discharge completely before opening the enclosure.



WARNING!

All electrical installations must be done in accordance with all local electrical codes and the National Electrical Code (NEC), ANSI/NFPA 70.



WARNING!

Before connecting the Sunny Boy to the electrical utility grid, contact the local utility company. This connection must be made only by qualified personnel.

5.1.2 Wiring with SMA DC-Disconnect



WARNING!

Always connect the wires to the Sunny Boy in the following sequence:

1. De-energize all energy sources by opening all AC and DC switch disconnects and/or breakers .
2. Wiring from the AC breaker to the SMA DC-Disconnect, follow the procedure on page 50 et seq..
3. AC wiring from the SMA DC-Disconnect to the Sunny Boy, follow the procedure on page 50 et seq..
4. Wiring from the PV array to the SMA DC-Disconnect, follow the procedure on page 60 et seq..
5. DC wiring from the SMA DC-Disconnect to the Sunny Boy, follow the procedure on page 60 et seq..
6. Switch the SMA DC-Disconnect to the "1" position.
7. Turn the AC breaker ON.

To disconnect the Sunny Boy, first turn OFF all AC disconnects and turn the SMA DC-Disconnect to the "0" position. The AC system should always be disconnected before the DC system. After the Sunny Boy is de-energized, disconnect the wiring in the reverse order from above.



WARNING!

Always wait a minimum of 5 minutes for stored potentials in the Sunny Boy to discharge completely before opening the enclosure.



WARNING!

All electrical installations must be done in accordance with all local electrical codes and the National Electrical Code (NEC), ANSI/NFPA 70.



WARNING!

Before connecting the Sunny Boy to the electrical utility grid, contact the local utility company. This connection must be made only by qualified personnel.

5.2 Bottom View and Dimensions

The DC input from the PV array (via the DC disconnect enclosure) and the output to the AC utility grid connect to the inverter inside the Sunny Boy's case. The internal AC and DC wiring terminals accept a maximum wire size of #6 AWG. Knockouts are provided on the bottom of the Sunny Boy near each of the terminals for the wires to enter the case, see Figure below.

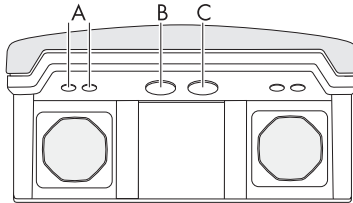

Position	Description
A	1/2" Communication Cable Glands
B	3/4" DC Knockout
C	3/4" AC Knockout



Information

The AC and DC knockouts are sized for 3/4 inch rigid conduit (EMT). DO NOT enlarge any of these holes, as this is a violation of UL requirements and will void the SMA warranty.

5.3 Opening the Sunny Boy

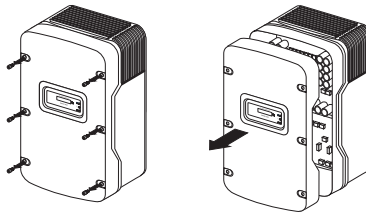

1. Remove the six screws from the housing cover and pull the cover forward smoothly.
2. Put the cover, the screws and the washers to one side so that they do not get lost.

5.4 Opening the SMA DC-Disconnect (if applicable)

1. Turn the SMA DC-Disconnect off by turning the switch to "0".

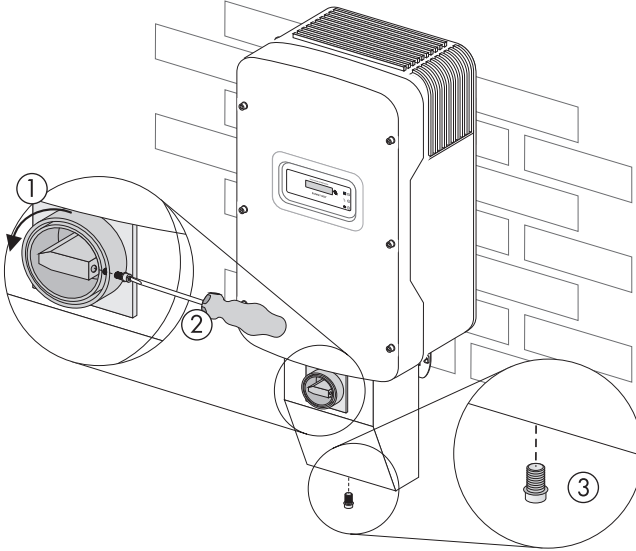

2. Loosen screw in the right area of the SMA DC-Disconnect with a small phillips screwdriver (used screw: UNC no 5 x 3/4", cross recess Phillips pan head machine screw). Do not remove the screw. Check if you can remove the knob of the SMA DC-Disconnect. If not, unscrew the screw further until you can remove the knob. The screw is attached with a rubber washer in order to make the assembly easier.
3. Remove the screw and the washer from the bottom side of the SMA DC-Disconnect, which fastens the cover.
4. Pull off the switch handle.
5. Remove the cover of the SMA DC-Disconnect by pulling it down and moving it at the same time carefully forward at its lower edge.

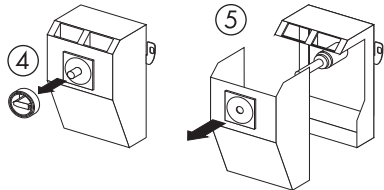

5.5 Wiring the AC Output

This subsection provides complete, step-by-step procedures for wiring the AC output from the Sunny Boy to the utility grid.

5.5.1 AC Connection Requirements



WARNING!

All electrical installations must be done in accordance with all local electrical codes and with the National Electrical Code (NEC), ANSI/NFPA 70. Use #6 AWG (maximum), 90 °C (194 °F), copper wire for all AC wiring connections to the Sunny Boy. Voltage drop and other considerations may dictate that larger size wires be used. Use only solid or stranded wire but not fine stranded wire.



WARNING!

The National Electrical Code (NEC) states that the inverter must be connected to a dedicated circuit, and that no other outlets or devices can be connected to the same circuit. See NEC Section 690-64(b)(1). The NEC also imposes limitations on the size of the inverter and the manner in which it is connected to the utility grid. See NEC Section 690-64(b)(2).



WARNING!

To reduce the risk of fire, connect only to a circuit provided with the required branch circuit overcurrent device sized in accordance with the National Electric Code, ANSI/NFPA 70. The maximum size overcurrent device shall not be more than 50 amperes.

The following diagrams show the potential losses in AC wires with respect to the cross-sectional area of the cable and the length of the cable. Use the following diagrams to determine the best wire size to use for your particular installation.

Sunny Boy 5000US Energy Losses in Various Wire Sizes and Wire Lengths

Percent voltage drop for 208 V AC and 240 V AC service

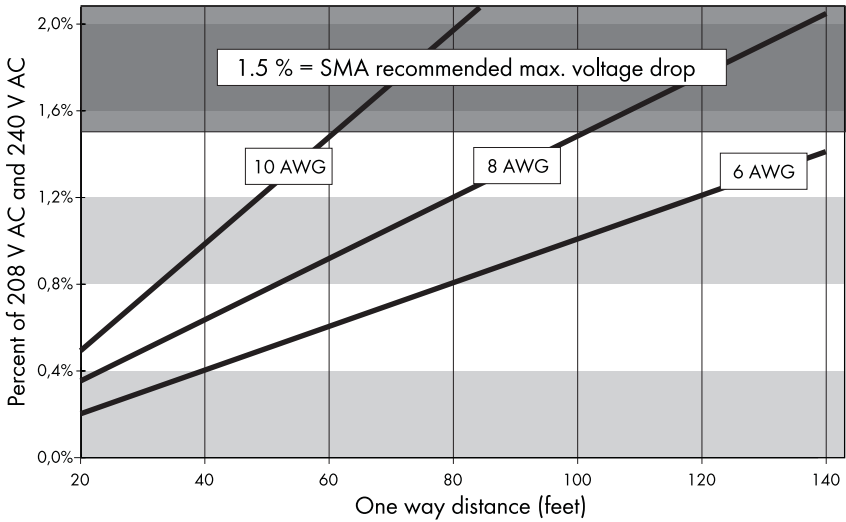

Percent voltage drop for 277 V AC service

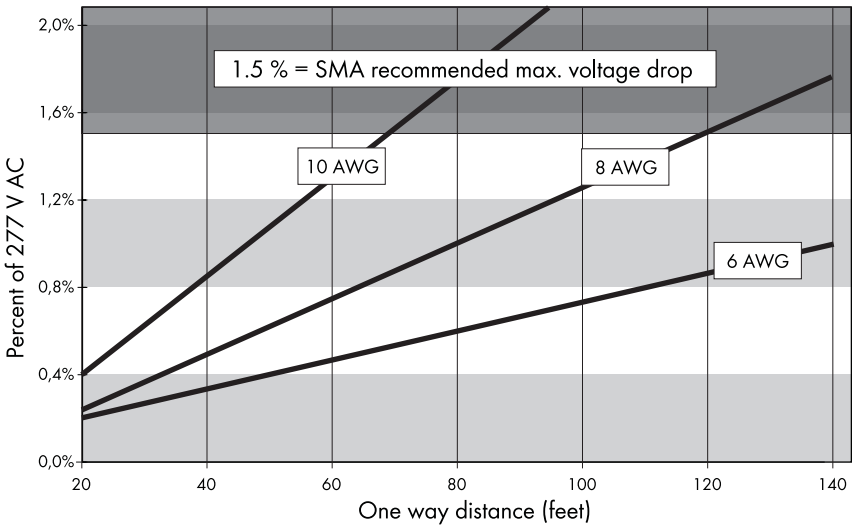

Sunny Boy 6000US Energy Losses in Various Wire Sizes and Wire Lengths

Percent voltage drop for 208 V AC and 240 V AC service

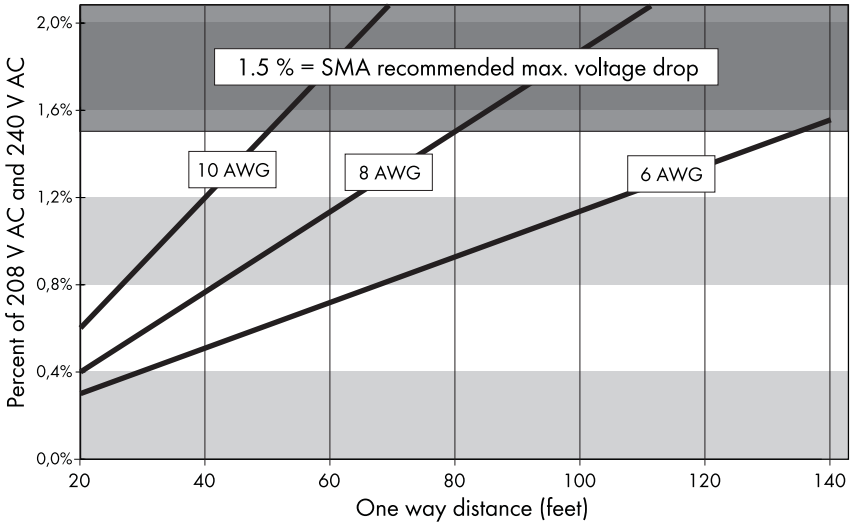

Percent voltage drop for 277 V AC service

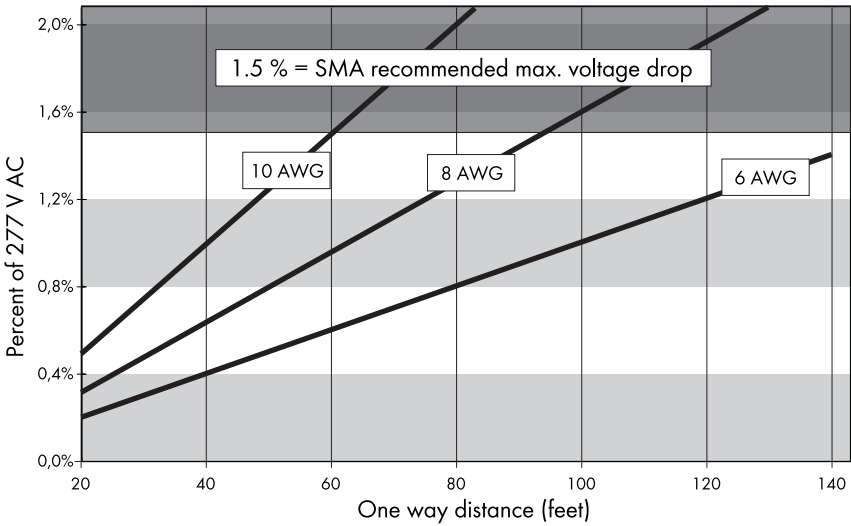

Sunny Boy 7000US Energy Losses in Various Wire Sizes and Wire Lengths

Percent voltage drop for 208 V AC and 240 V AC service

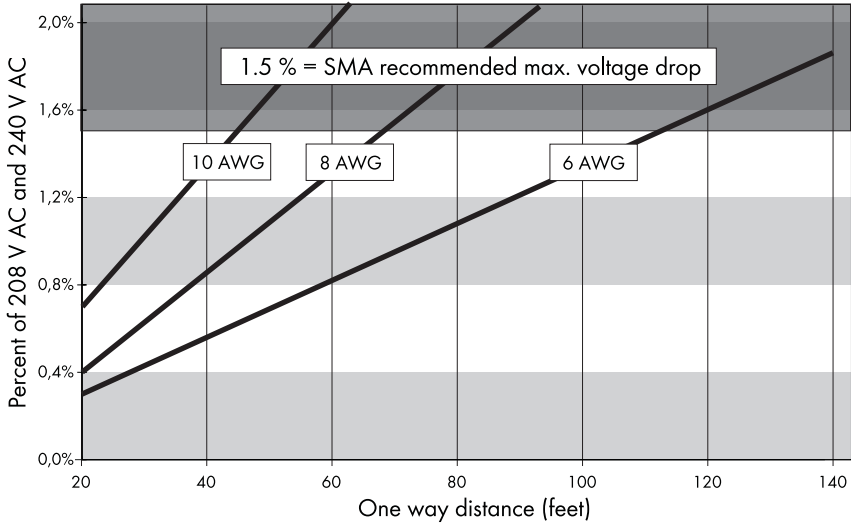

Percent voltage drop for 277 V AC service

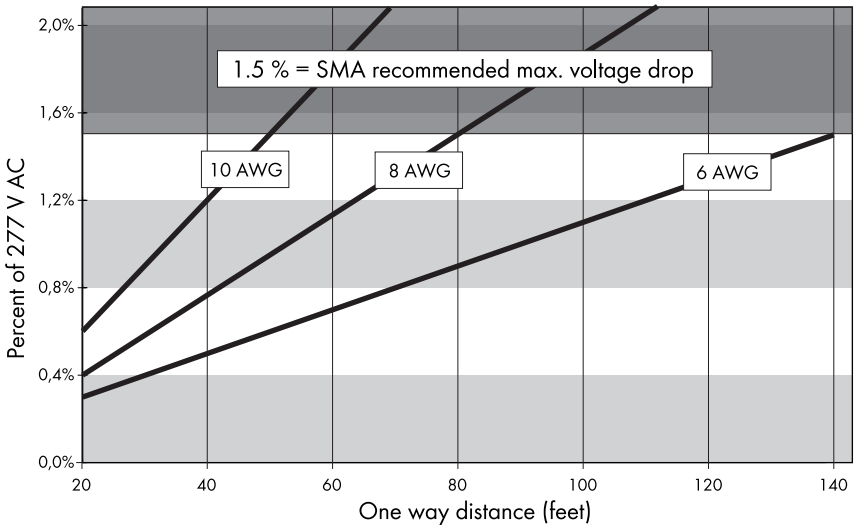

Sunny Boy 8000US Energy Losses in Various Wire Sizes and Wire Lengths

Percent voltage drop for 240 V AC service

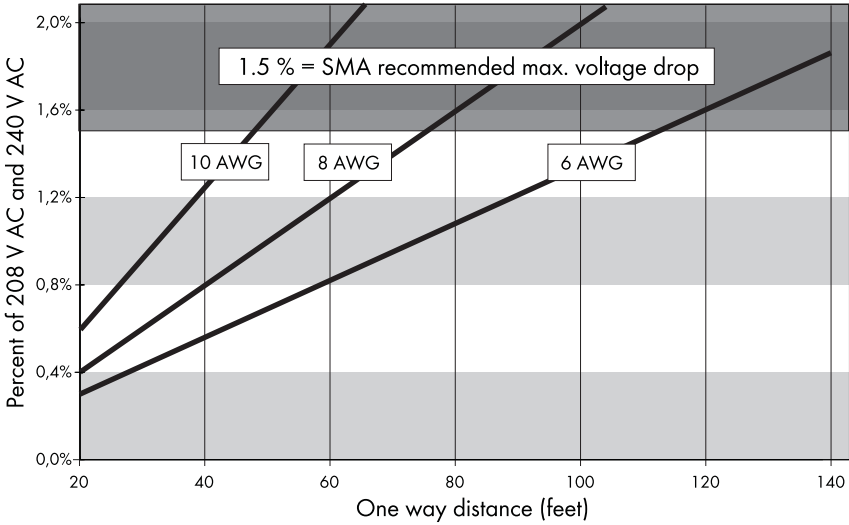

Percent voltage drop for 277 V AC service

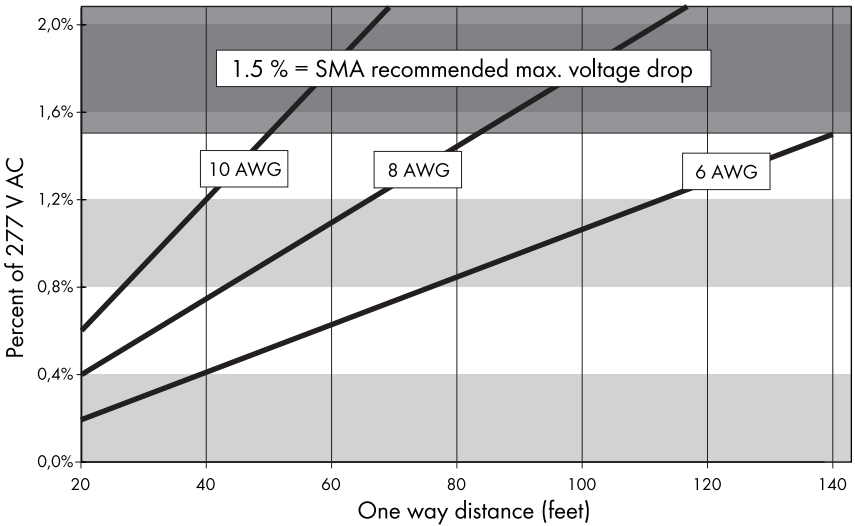

5.5.2 AC Wiring Without SMA DC-Disconnect

Use the following procedure to connect the AC wires to the Sunny Boy without the SMA DC-Disconnect:



WARNING!

You must connect the wires that carry the AC voltage from the Sunny Boy to the utility grid in the order described in this procedure. Deviating from this procedure could expose you to lethal voltages that can cause serious injury and/or death.

1. Turn OFF the main breaker in the main utility breaker box.
2. Remove interior breaker panel cover.
3. If you are replacing an existing inverter, disconnect the wires for the AC line you are working with in the breaker box.
4. Install a 3/4-inch conduit fitting in the Sunny Boy's AC wiring knockout (the knockout on the right side of the Sunny Boy, as shown in chapter 5.2 "Bottom View and Dimensions" (page 40)). Fasten the conduit fitting on the inside of the Sunny Boy with the appropriate locknut.
5. Install a 3/4-inch conduit between the main breaker box and the Sunny Boy's AC wiring knockout.
6. Pull the AC wires through the conduit from the interior of the breaker box to the interior of the Sunny Boy.
7. Refer to the figures on pages 48 and 49 for steps 8 through 10.



CAUTION!

Avoid using wire nuts to join any wires together or to make any connections anywhere in the PV system. Wire nuts are a frequent cause of unreliable, resistive connections, and ground faults.

8. Connect the AC equipment-ground wire to the PE terminal labeled  in the Sunny Boy.



The Sunny Boy 8000US may not be connected to a 208 V grid.

9. For 208/240/277 V connect the L1 (AC line 1 or UNGROUNDED) wire to the terminal labeled L1 in the Sunny Boy.
10. For 208/240 V connect the L2 (AC line 2) and N (AC line N) wire to the terminal labeled L2 and N in the Sunny Boy. For 277 V connect the N (AC line N) wire to the terminal labeled N in the Sunny Boy.

Note: For 277 V the L2 terminal is not used.



The terminal must be opened completely before you insert the cable.

11. Connect the wires to the terminal blocks in the Sunny Boy and tighten them. Torques for AC connection terminal blocks:

Grey Terminal Blocks (Weidmüller)	10 - 6 AWG: 18 in-lb (2 Nm)
Green Terminal Blocks (Phoenix)	8 - 6 AWG: 40 in-lb (4.5 Nm)
	10 AWG: 22 in-lb (2.5 Nm)

12. Verify that all connections are correctly wired and properly torqued. Pull on the cable in order to make sure that it is sufficiently fixed in the terminal.

AC Connection Terminals for 208 V (not for Sunny Boy 8000US) and 240 V

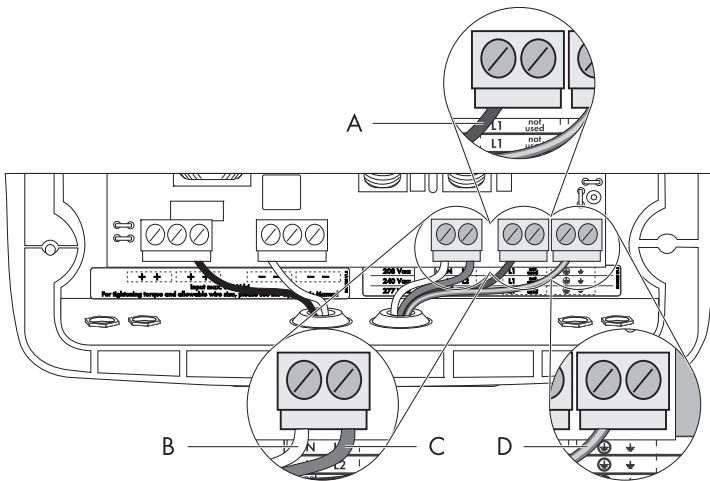

Position	Description
A	L1 wire connected to L1 terminal
B	N wire connected to N terminal
C	L2 wire connected to L2 terminal
D	Equipment ground wire connected to PE terminal

AC Connection Terminals for 277 V

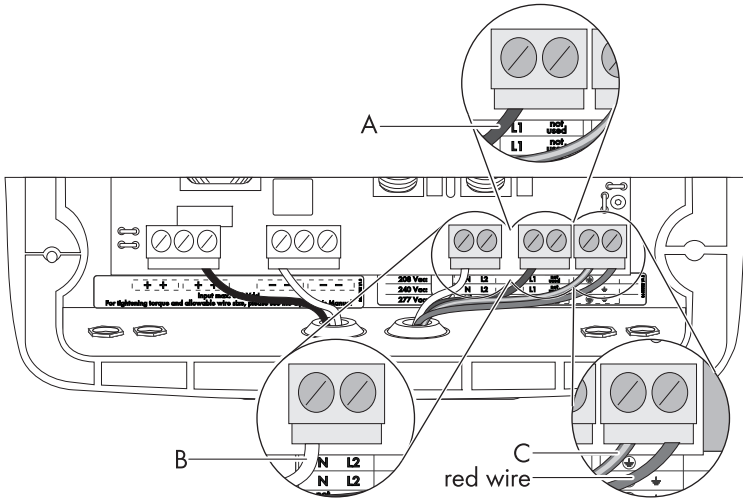

Position	Description
A	L1 wire connected to L1 terminal
B	N wire connected to N terminal
C	Equipment ground wire connected to PE terminal

5.5.3 AC Wiring With SMA DC-Disconnect

Use the following procedure to connect the AC wires to the Sunny Boy with the SMA DC-Disconnect:



WARNING!

You must connect the wires that carry the AC voltage from the Sunny Boy to the utility grid in the order described in this procedure. Deviating from this procedure could expose you to lethal voltages that can cause serious injury and/or death.

1. Turn OFF the main breaker in the main utility breaker box.
2. Remove interior breaker panel cover.
3. If you are replacing an existing inverter, disconnect the wires for the AC line you are working with in the breaker box.
4. Install a 3/4-inch conduit fitting in the SMA DC-Disconnect AC wiring knockout (the knockout on the right side of the SMA DC-Disconnect). Fasten the conduit fitting on the inside of the SMA DC-Disconnect with the appropriate locknut.
5. Install 3/4-inch conduit between the main breaker box and the SMA DC-Disconnect's AC wiring knockout.
6. Pull the AC wires through the conduit from the interior of the breaker box to the interior of the SMA DC-Disconnect.



CAUTION!

Avoid using wire nuts to join any wires together or to make any connections anywhere in the PV system. Wire nuts are a frequent cause of unreliable, resistive connections, and ground faults.



The terminal must be opened completely before you insert the cable.

7. Connect the AC equipment-ground wire to the PE terminal labeled  in the SMA DC-Disconnect.

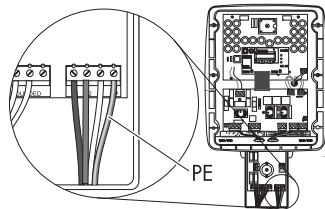

- 8. For 208/240/277 V connect the L1 (AC line 1 or UNGROUNDED) wire to the terminal labeled L1 in the SMA DC-Disconnect.

The Sunny Boy 8000US may not be connected to a 208 V grid.

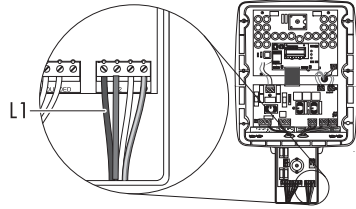

- 9. For 208/240 V connect the L2 (AC line 2) and N (AC line N) wire to the terminal labeled L2 and N in the SMA DC-Disconnect.

The Sunny Boy 8000US may not be connected to a 208 V grid.

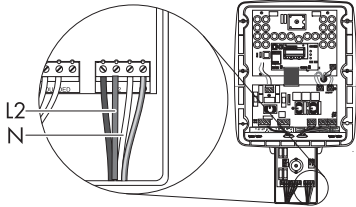

For 277 V connect the N (AC line N) wire to the terminal labeled N in the SMA DC-Disconnect.

Note: For 277 V the L2 terminal is not used.

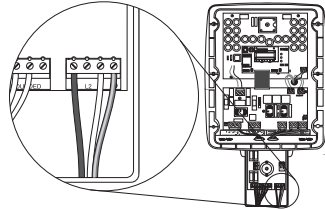

- 10. Connect the wires to the terminal blocks in the SMA DC-Disconnect and tighten to a torque of 15 in-lb (1.7 Nm).
- 11. Use a screwdriver in order to poke a hole in the groove of the grommet inside the inverter.

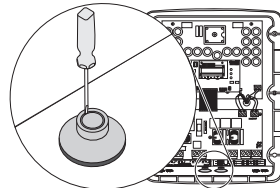

- 12. Remove the membrane.

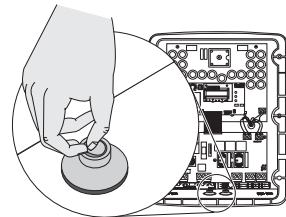

13. Pull the cable into the Sunny Boy.

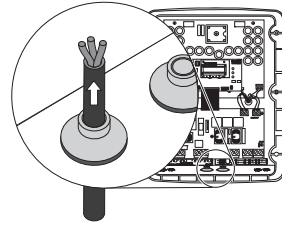

14. Pull the cable slightly back in order to seal the grommet.

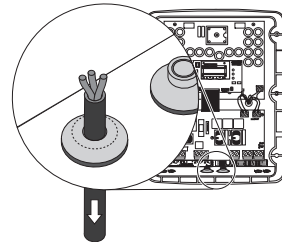

15. Connect the green/yellow cable of the Sunny Boy to the terminal labeled: 

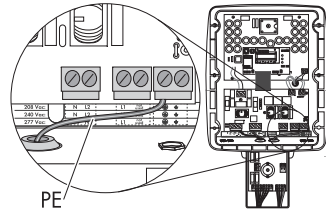

16. Connect the white wire of the SMA DC-Disconnect to the terminal labeled N and the black wire to the terminal labeled L1 of the Sunny Boy.

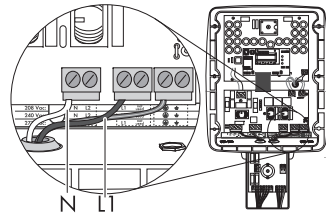

17. For 208/240 V connect the red wire to the terminal labeled L2 in the Sunny Boy.
The Sunny Boy 8000US may not be connected to a 208 V grid.

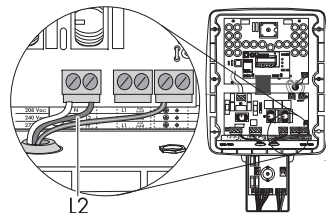

For 277 V connect the red wire to the terminal labeled \perp in the Sunny Boy (not used).

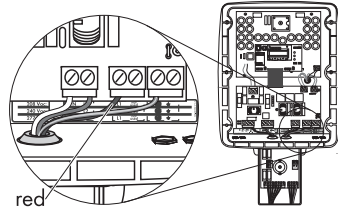

18. Connect the wires to the terminal blocks in the Sunny Boy and tighten them. Torques for AC connection terminal blocks:

Grey Terminal Blocks (Weidmüller)	10 - 6 AWG: 18 in-lb (2 Nm)
Green Terminal Blocks (Phoenix)	8 - 6 AWG: 40 in-lb (4.5 Nm)
	10 AWG: 22 in-lb (2.5 Nm)

19. Verify that all connections are correctly wired and properly torqued. Pull on the cable in order to make sure that it is sufficiently fixed in the terminal.

5.6 Wiring the DC Input

This subsection provides procedures for wiring the DC input from the PV array to the Sunny Boy. The figure below shows a simplified wiring diagram of a PV system.

Simplified Electrical Wiring Diagram of a PV System

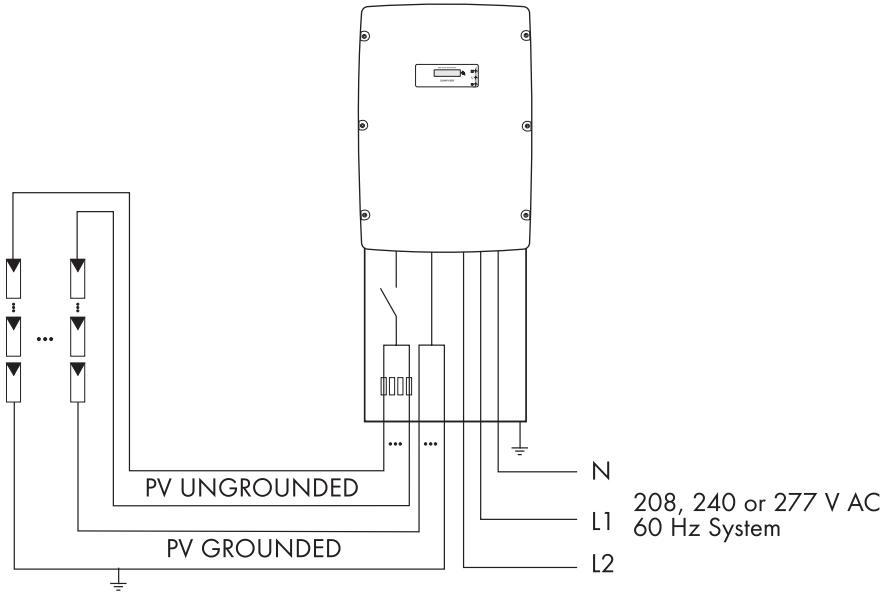

5.6.1 DC Connection Requirements



WARNING!

All electrical installations must be done in accordance with all local electrical codes and with the National Electrical Code (NEC), ANSI/NFPA 70. For installation in Canada the installations must be done in accordance with applicable Canadian standards.



WARNING!

Use #10 AWG to # 6 AWG, 90 °C (194 °F), copper wire for all DC wiring connections to the Sunny Boy. Voltage drop and other considerations may dictate that larger size wires be used. Use only solid or stranded wire but not fine stranded wire.



WARNING!

The DC disconnect for the inverter must have a minimum rating of 600 V DC and 36 A continuous. The SMA DC disconnect is shipped with four 15 A, 600 V DC fuses (one for each string). The maximum fuse rating for the four SMA DC disconnect fuses is 20 A, 600 V DC (one for each string). For fuse sizing please refer to NEC 690.9.



Use the online SMA string size calculator at www.sma-america.com to determine the correct string configuration. To navigate to the string size calculator, click on the shortcut on the home page.



Series fusing may be required depending on the type of PV module used in the system. See NEC 690.9.

5.7 DC Input Grounding

The Sunny Boy comes from the factory configured for negative ground systems. Certain types of PV modules may require that the positive terminal be grounded instead of the negative terminal. To configure the Sunny Boy for positive ground, move the fuse (1) and change the jumper position (2) as shown in the following illustrations.

GFDI Fuse and Jumper Settings for Negative Ground

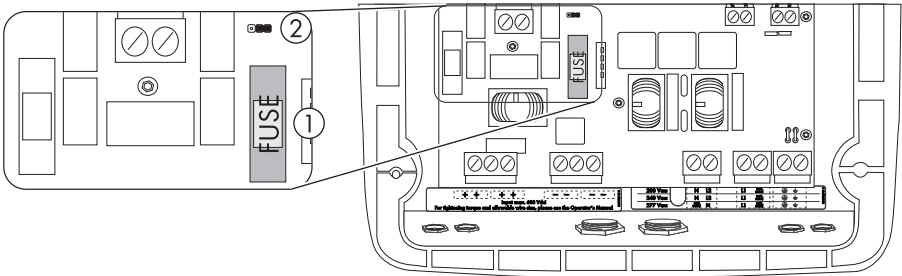

GFDI Fuse and Jumper Settings for Positive Ground

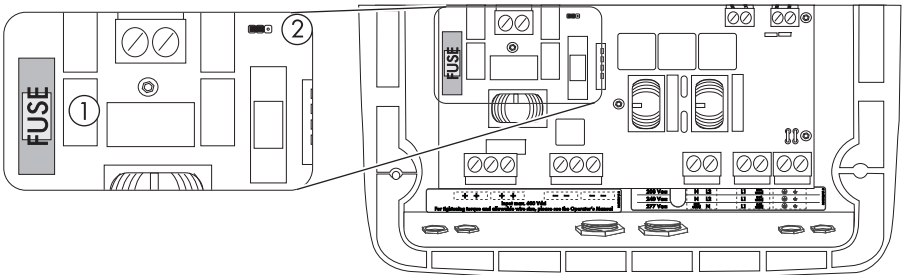

5.8 Connecting the DC Wires



WARNING!

You must connect the wires that carry the DC voltage from the PV array to the Sunny Boy in the order described in the following procedure. Deviating from this procedure could expose you to lethal voltages that can cause serious injury and/or death.



WARNING!

PV arrays are energized when exposed to light. Use safe working practices when working on PV arrays.



WARNING!

Always turn OFF all AC and DC breakers and switches in the PV system and wait a minimum of 5 minutes for the Sunny Boy to completely discharge before connecting any wires to the Sunny Boy or disconnecting any wires from the Sunny Boy. Failure to do so could expose you to lethal voltages that can cause serious injury and/or death.



CAUTION!

Verify the polarity and the open-circuit voltage from the PV strings before you connect the DC wires to the Sunny Boy. Applying an open-circuit DC-input voltage that exceeds the maximum DC-input-voltage range will cause irreversible damage to the Sunny Boy and void the warranty! Always configure the DC-input-voltage range correctly before connecting the DC-input wires from the PV array to the Sunny Boy. Use the online SMA string size calculator at www.sma-america.com to determine the correct string configuration.



WARNING!

Verify that the DC current of your installation does not exceed the maximum values specified in the type rating label.

Check both the polarity and the open-circuit voltage from the PV strings!

5.8.1 DC Wiring Without SMA DC-Disconnect

Use the following procedure to connect the DC wires to the Sunny Boy without SMA DC-Disconnect:

1. Verify that the AC breaker is OFF.
2. Verify that the DC disconnect is open in the external DC disconnect enclosure.
3. Install a 3/4-inch conduit fitting in the Sunny Boy's DC wiring knockout. The DC knockout is the left one of the two large openings in the center on the bottom of the Sunny Boy, as shown in chapter 5.2 "Bottom View and Dimensions" (page 40) and in the figure below. Fasten the conduit fitting on the inside of the Sunny Boy with the appropriate locknut.
4. Install 3/4-inch conduit between the DC disconnect enclosure and the Sunny Boy's DC wiring knockout.
5. Refer to the figure below for steps 6 through 8.

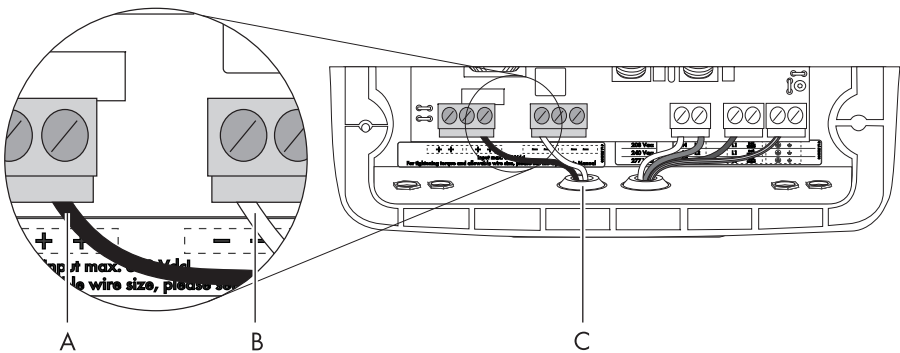

Position	Description
A	Positive DC wire connected to DC+
B	Negative DC wire connected to DC-
C	DC Knockout

6. Pull the DC wires from the DC disconnect through the conduit into the interior of the Sunny Boy.
7. Connect the positive DC wire to the terminal labeled DC+ in the Sunny Boy.
8. Connect the negative DC wire to the terminal labeled DC- in the Sunny Boy.



The Sunny Boy has provisions for up to three PV strings. The positive and negative terminal blocks each have three positions, so three pairs of DC-input wires can be connected in parallel.



CAUTION!

Avoid using wire nuts to join any wires together or to make any connections anywhere in the PV system. Wire nuts are a frequent cause of unreliable, resistive connections, and ground faults.



The terminal must be opened completely before you insert the cable.

9. Connect the positive and negative DC wires to the appropriate terminals in the DC disconnect enclosure.
10. Connect the DC equipment ground wire to the PE terminal labeled  in the Sunny Boy.
11. Torque all wires in the AC and DC terminal blocks inside the Sunny Boy to:

Grey Terminal Blocks (Weidmüller)	10 - 6 AWG: 18 in-lb (2 Nm)
Green Terminal Blocks (Phoenix)	8 - 6 AWG: 40 in-lb (4.5 Nm)
	10 AWG: 22 in-lb (2.5 Nm)

12. Verify that all connections are correctly wired and properly torqued. Make a tension test.

5.8.2 DC Wiring With SMA DC-Disconnect



CAUTION!

Avoid using wire nuts to join any wires together or to make any connections anywhere in the PV system. Wire nuts are a frequent cause of unreliable, resistive connections, and ground faults.



The terminal has to be fully opened before you insert the cable into it.

Use the following procedure to connect the DC wires to the Sunny Boy with SMA DC-Disconnect:

1. Verify that the AC breaker is OFF.
2. Install a 3/4-inch conduit fitting in the SMA DC-Disconnect's DC wiring knockout (the knockout on the left side of the SMA DC-Disconnect). Fasten the conduit fitting on the inside of the SMA DC-Disconnect with the appropriate locknut.
3. Install 3/4-inch conduit between the SMA DC-Disconnect and the PV array.
4. Pull the DC wires, the ground wires from the PV array and the grounding electrode wire through the conduit into the interior of the SMA DC-Disconnect.



The SMA DC-Disconnect has provisions for up to four PV strings. The PV UNGROUNDED and PV GROUNDED terminal block each has four positions, so four pairs of DC-input wires can be connected in parallel.

5. Connect the grounding electrode to the grounding electrode conductor terminal (B).
6. Connect the PV generator grounding to the grounding electrode conductor terminal (A).

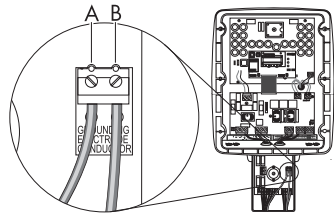

Negative Grounding



To verify that your inverter is grounded as intended please refer to section 5.7 "DC Input Grounding" (page 56).

7. Connect the positive DC wires (A) to the terminal labeled PV UNGROUNDED in the SMA DC-Disconnect.

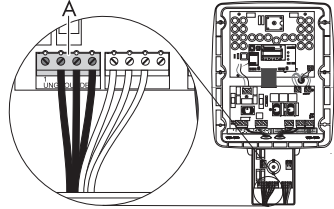

8. Connect the negative DC wires (A) to the terminal labeled PV GROUNDED in the SMA DC-Disconnect.

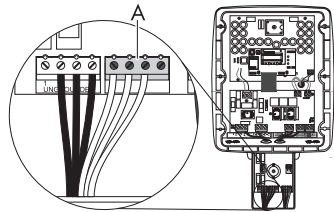

9. Torque all wires in the terminal blocks inside the SMA DC-Disconnect to 15 in-lb (1.7 Nm).
10. Use a screwdriver in order to poke a hole in the groove of the grommet.

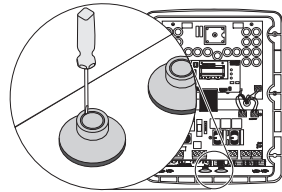

11. Remove the membrane.

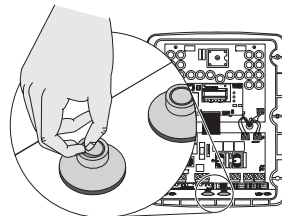

12. Pull the DC wires from the DC disconnect through the conduit into the interior of the Sunny Boy.

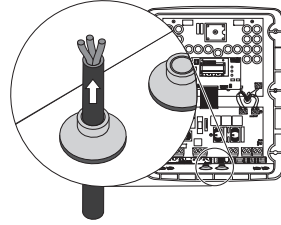

13. Pull the wires slightly back in order to seal the grommet.

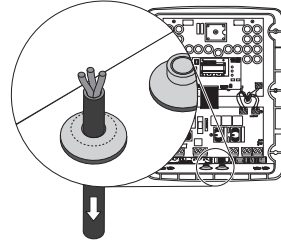

14. Connect the black wire (PV UNGROUNDED) to the terminal labeled DC+ in the Sunny Boy.

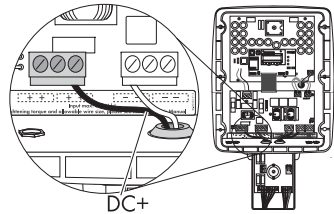

15. Connect the white wire (PV GROUNDED) to the terminal labeled DC- in the Sunny Boy.

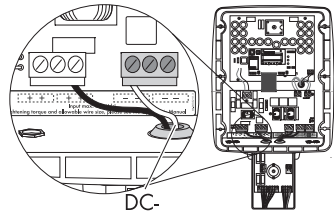

16. Torque all wires in the terminal blocks inside the Sunny Boy to:

Grey Terminal Blocks (Weidmüller)	10 - 6 AWG: 18 in-lb (2 Nm)
Green Terminal Blocks (Phoenix)	8 - 6 AWG: 40 in-lb (4.5 Nm)
	10 AWG: 22 in-lb (2.5 Nm)

Verify that all connections are correctly wired and properly torqued. Make a tension test.

Positive Grounding



To verify that your inverter is grounded as intended please refer to section 5.7 "DC Input Grounding" (page 56).

1. Connect the negative DC wires (A) to the terminal labeled PV UNGROUNDED in the SMA DC-Disconnect.

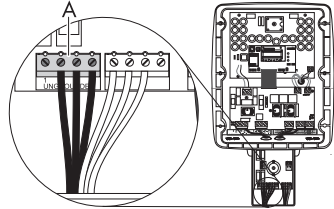

2. Connect the positive DC wires (A) to the terminal labeled PV GROUNDED in the SMA DC-Disconnect.

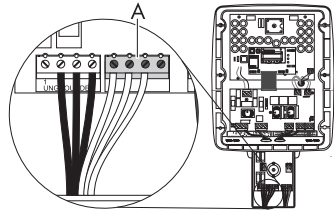

3. Torque all wires in the terminal blocks inside the SMA DC-Disconnect to 15 in-lb (1.7 Nm).
4. Use a screwdriver in order to poke a hole in the groove of the grommet.

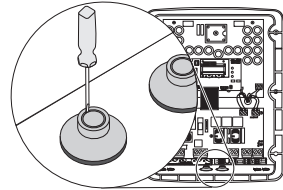

5. Remove the membrane.

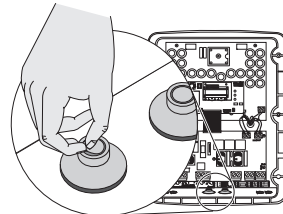

6. Pull the DC wires from the DC disconnect through the conduit into the interior of the Sunny Boy.

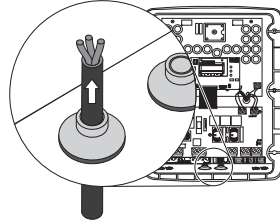

7. Pull the wires slightly back in order to seal the grommet.

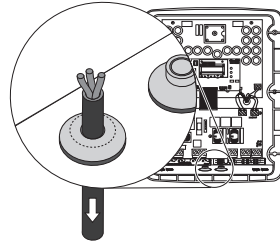

8. Connect the white wire (PV GROUNDED) to the terminal labeled DC+ in the Sunny Boy.

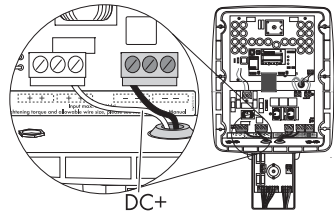

9. Connect the black wire (PV UNGROUNDED) to the terminal labeled DC- in the Sunny Boy.

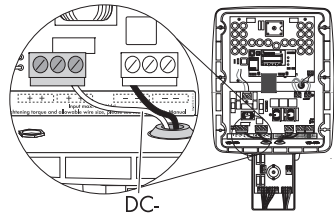

10. Torque all wires in the terminal blocks inside the Sunny Boy to:

Grey Terminal Blocks (Weidmüller)	10 - 6 AWG: 18 in-lb (2 Nm)
Green Terminal Blocks (Phoenix)	8 - 6 AWG: 40 in-lb (4.5 Nm)
	10 AWG: 22 in-lb (2.5 Nm)

11. Verify that all connections are correctly wired and properly torqued.

5.8.3 DC Connection With Additional DC Distribution Using Spring Terminal Labeled Combined

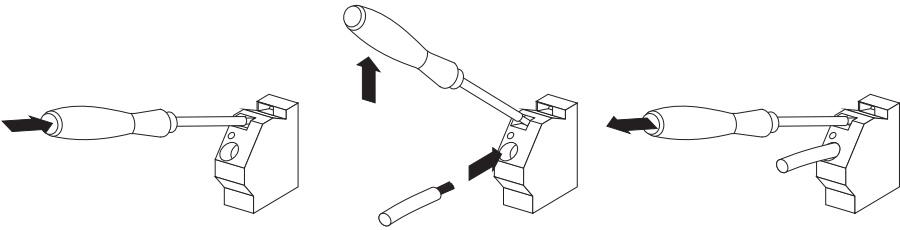

1. Insert the insulated screwdriver into the provided slot of the spring terminal.
2. Push the screwdriver up, the spring terminal is opened.
3. Insert the stripped cable into the spring terminal.
4. Return the screwdriver to its original position.
5. Remove the screwdriver. The spring terminal is closed and the cable is fastened.

DC Connection With Additional DC-Distribution, Negative Grounding

1. Connect the positive DC wire (A) to the terminal labeled COMBINED in the SMA DC-Disconnect.

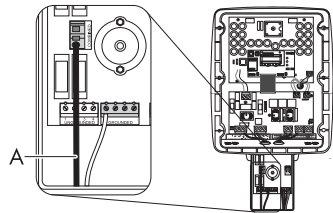

2. Connect the negative DC wire (A) to the terminal labeled PV GROUNDED in the SMA DC-Disconnect.

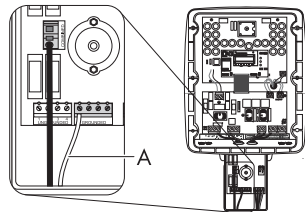

3. Torque all wires in the terminal blocks inside the SMA DC-Disconnect to 15 in-lb (1.7 Nm).

DC Connection With Additional DC-Distribution, Positive Grounding

1. Connect the negative DC wire (A) to the terminal labeled COMBINED in the SMA DC-Disconnect.
2. Connect the positive DC wire (A) to the terminal labeled PV GROUNDED in the SMA DC-Disconnect.

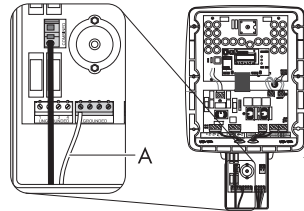
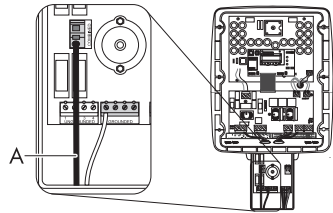

3. Torque all wires in the terminal blocks inside the SMA DC-Disconnect to 15 in-lb (1.7 Nm).

5.9 Communication

The Sunny Boy can be retrofitted with a communication interface (socket see section 3.2 "Locating Internal Components" (page 19)) to communicate with special data acquisition devices (e.g. Sunny WebBox) or a PC with appropriate software (e.g. Sunny Data).

For a complete listing of all applicable communication options please refer to the SMA web page or the product catalogue.

See the communication interface documentation for a detailed wiring diagram and instructions for insertion.

5.10 Closing the Sunny Boy

When you have finished connecting the AC-output wires, the DC-input wires, and the communication cables, re-check all your connections to ensure that everything is in the right place and that all connections and knockout fittings are secure and properly torqued. Check all of the knockout fittings on the bottom of the Sunny Boy to ensure that they provide a weather-tight seal.



WARNING!

Never install the Sunny Boy during rain or very damp conditions. Because the Sunny Boy is completely sealed, you must be sure no moisture is trapped inside the enclosure when securing the lid.

**CAUTION!**

Be careful not to misplace the screws or the lock washers that attach the cover to the case, as all six screws and lock washers are required to ensure that the cover is grounded properly and is fully sealed to the case. Handle the cover carefully, as even minor damage to the cover could result in an inadequate seal between the cover and the case, thus allowing moisture to enter the case and damage the sensitive electronic components.

Use the following procedure to replace the cover on the Sunny Boy:

1. Check wire routing to ensure that no wires can interfere with proper sealing of the cover and that no pressure will be exerted on the connections when the cover is replaced.
2. Locate the six screws and lock washers you removed to take the cover off the Sunny Boy. Make sure you have all six screws and lock washers, as all of this hardware is necessary to ensure proper grounding and a weather-tight seal.
3. Check the seal on the inside of the cover to ensure it is undamaged and in the correct position.
4. Carefully position the cover on the front of the Sunny Boy so that the six holes in the cover are aligned correctly with the six threaded holes in the case.



Be sure when reinstalling the six screws that the lock washers are installed correctly. The teeth of the washers should face towards the lid.

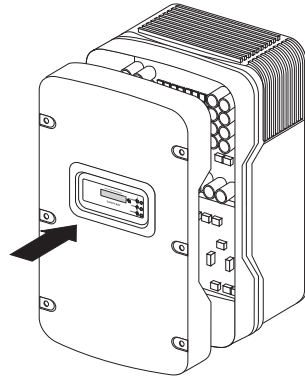

5. While holding the cover in place, carefully insert the six screws with lock washers through the holes in the cover into the threaded holes in the case and turn them until they are finger-tight. Be careful not to cross-thread any of the screws. Do not use power tools to start the screws.
6. Verify that the cover is in the correct position and that the seal is in place between the case and the cover.
7. Tighten the cover screws to a torque of 53 in-lbs. (6 Nm).

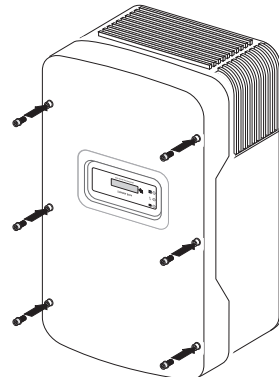

5.11 Closing the SMA DC-Disconnect (if applicable)

1. Make sure the string fuses are securely mounted.

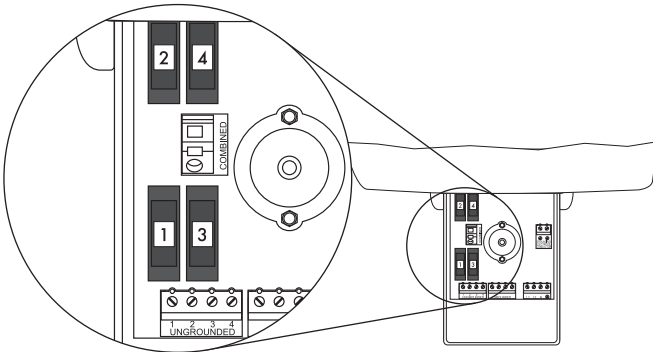

2. Position the cover onto the SMA DC-Disconnect and insert the switch handle into the cover.
3. Turn the switch to the "0" position and tighten the screw on the right side of the switch with a small phillips screwdriver (used screw: UNC no 5 x 3/4", cross recess Phillips pan head machine screw).
4. Install the screw and washer on the bottom side of the SMA DC-Disconnect, to fasten the cover. The teeth of the washer must face toward the cover in order to ensure proper grounding. Tighten the screw to a torque of 44 in-lb (5 Nm).

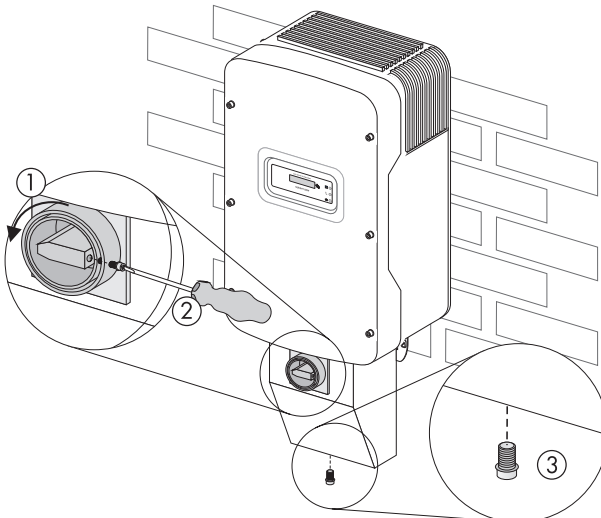
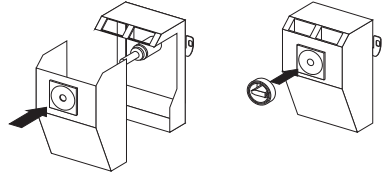

6 Commissioning



WARNING!

Follow the steps in the commissioning procedure in the order they are presented. Deviating from these procedures could expose you to lethal voltages that can cause serious injury and/or death.



WARNING!

Never insert the GFDI fuse into the Sunny Boy without the fuse holder base. Latent voltage may still be present and electric shock may result.



CAUTION!

Follow the steps in the commissioning procedure in the order they are presented. Deviating from these procedures could cause irreversible damage to the Sunny Boy and void the warranty.

All Sunny Boy inverters have a sophisticated system for detecting and responding to PV array ground faults as required by NEC Section 690.5. The PV array normally operates in a grounded configuration. Depending on the type of system, the array's negative or positive conductor is connected to the grounding system inside the inverter as a part of the UL1741 Listed ground-fault detection system. The GFDI protection is active whenever there is sufficient DC voltage to turn on the LCD in the Sunny Boy.

To commission the Sunny Boy, follow these simple instructions:

1. Make sure any covering placed over the PV array is removed.
2. Connect the grid voltage to the Sunny Boy by switching on the main AC circuit breaker in the main utility panel.
3. Switch the external DC disconnect to the „on“ position or switch the SMA DC-Disconnect to the “1” position. If there is sufficient sunlight available, the Sunny Boy will enter the “Wait” mode at this time and the green LED will begin to blink.
4. If no AC faults are detected, the “Wait” mode will end after 10 seconds and the green LED will stop blinking, remain on and the Sunny Boy will begin to operate normally. If an AC fault was registered, the Sunny Boy will wait 5 minutes prior to starting.



If there is a ground fault in the array, the “EarthCurrentMax” error message will be displayed and the GFDI fuse may clear. If this error message is encountered, switch off the DC and AC disconnects to the Sunny Boy and troubleshoot the array.



If the Sunny Boy is not operating as expected after the commissioning procedure has been completed, refer to Section 7 "Displays and Messages" (page 71) and to Section 8 "Troubleshooting" (page 86).



If there is adequate solar irradiation and the resulting PV input voltage is greater than 300 V DC (365 V DC for Sunny Boy 8000US), the Sunny Boy will automatically begin feeding power to the utility grid.



The Sunny Boy operates from the power produced by the PV array and is designed for minimal internal DC-power consumption. The maximum power that the Sunny Boy will consume in normal operation is 7 W.



Anytime the AC power is disconnected from the inverter, either manually or as a result of an AC disturbance, the inverter will wait 5 minutes after the AC power has been restored to reconnect. When servicing the inverter, always disconnect the DC first, then the AC.

7 Displays and Messages

The Sunny Boy LED Status Indicator

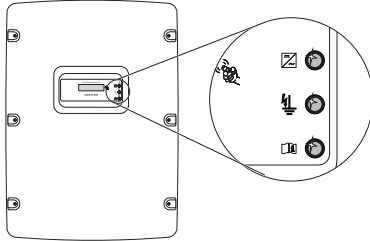

Each Sunny Boy inverter comes equipped with three LED status indicators. (Shown in the figure above) This allows the user to determine the operating mode of the inverter at a glance.

The basic definitions of the indicator lights are as follows:

The green LED indicates normal operation of the inverter.

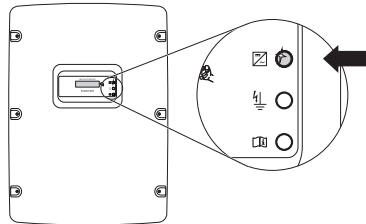

The red LED indicates the status of the GFDI fuse, located inside the Sunny Boy. If this LED is lit, the GFDI fuse has cleared or is not present.

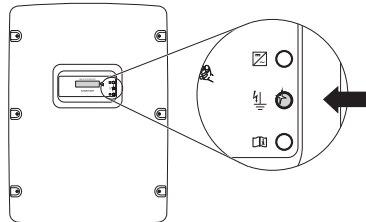

The yellow LED indicates that there is a fault of some kind, either inside the inverter or somewhere in the PV system. The inverter will not operate until the fault has been corrected. The different error codes and possible causes are addressed later in this section and in Section 8 "Troubleshooting" (page 86).

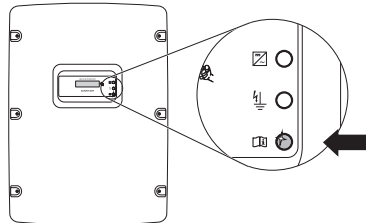

The red and yellow LEDs combined indicate that the inverter has detected a ground fault. The ground fault must be located and cleared and the inverter reset manually. The inverter will not restart automatically after detecting a ground fault. The ground fault may also clear the GFDI fuse.

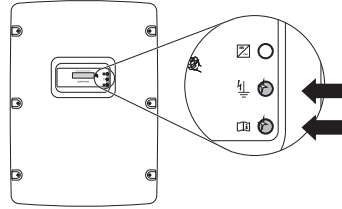

All GFDI fuses are disabled in turbine mode.

7.1 LED Operation Indicators

Standby (Night)

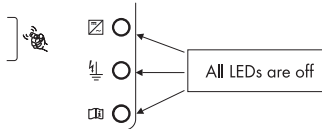

The inverter is in standby mode because the input voltage is too low for operation.

Initialization

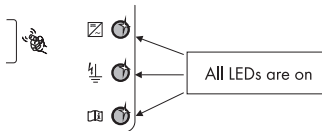

The inverter is initializing. The power from the array is sufficient to initialize control power, but not yet powerful enough to begin normal operation. Data transmission is not possible during initialization.

Occasionally, during inclement weather or low irradiation, the LEDs may all turn on at once and then go off again. This indicates that the inverter is trying to initialize but the power available from the array is not sufficient for normal operation. This is not a malfunction.

Starting

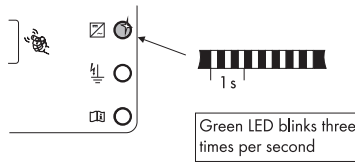

The inverter has sufficient PV power to calibrate its internal systems, but not enough to begin normal operation. Typically, the calibration lasts less than 10 seconds and then the inverter resumes normal operation. PV voltage must remain > PV Start Voltage setting for the period of the P-Start parameter setting. (See chapter 8 "Troubleshooting" (page 86)) The inverter will also show this status if it has been manually set to STOP mode.

Waiting

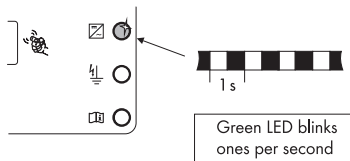

The inverter has determined that there is enough voltage from the array to operate and is checking the condition of the grid prior to connecting to it.



If the inverter fails to connect to the utility grid 3 times in a row, it will wait 10 minutes before the next attempt.

In case of a grid failure, the Sunny Boy waits 5 minutes before it tries to reconnect to the grid.

Normal Operation

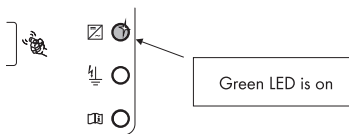

The inverter is feeding the utility grid in either "MPP", "Constant Voltage" or "Turbine" mode.

"MPP" Mode: The Sunny Boy adjusts the voltage and current from the PV array to obtain the greatest PV output power.

"Constant Voltage" Mode: The voltage from the PV array has been set to a fixed value. This value is set by using the Sunny Boy Control or the Sunny Data software. (The parameter name is "V-Const") This mode is typically used for fuel cell or micro-hydro applications.

"Turbine" Mode: This mode is used for DC rectified motor sources with a dynamic power curve (typically wind turbines). The user can set the magnitude and slope of the curve to match a particular alternator.

Derating

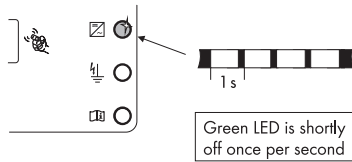

The Sunny Boy is designed to operate at full rated power up to 45 °C ambient. The inverter will continue to operate beyond 45 °C and will derate as required to maintain a safe internal component temperature. Unnecessary derating can be caused by blocked fan intakes. For this reason the fan intakes should be inspected often and cleaned when needed.

7.2 LED Fault Indicators

Ground Fault

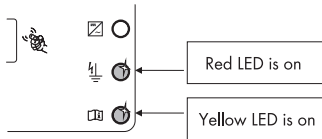

The inverter has detected a ground fault in the PV system and has disconnected from the grid. The ground fault must be located and fixed before the inverter will resume normal operation. Refer to Section 8 "Troubleshooting" (page 86) for information on solving PV array ground faults. (The inverter will not restart automatically)

All GFDI fuses are disabled in turbine mode.

Cleared GFDI Fuse

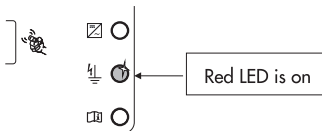

The GFDI fuse located in the fuse holder on the circuit board of the inverter has been cleared or is not present. This fuse is used to protect the PV system in the event of an array ground fault. Troubleshoot the PV array for ground faults prior to replacing this fuse.



CAUTION!

For continued protection against the risk of fire, replace the GFDI fuse with fuses of the same type and rating only. The Sunny Boy is shipped with a Littelfuse KLKD 1 Amp, 600V AC/DC type fuse.

Control System Fault

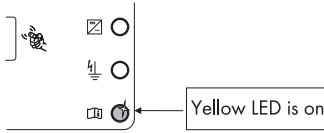

The yellow LED remains lit.

The Sunny Boy has detected a fault within the internal monitoring systems. When the inverter detects a fault of this kind it will no longer connect to the utility grid. To correct this, the inverter must be serviced by a qualified service technician. Contact SMA America for assistance.

Grid Failure

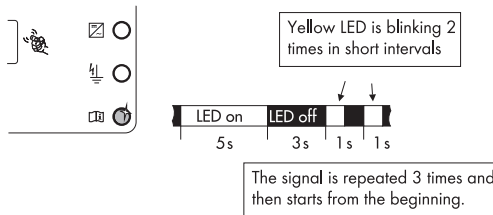

The yellow LED is on for 5 seconds, out for 3 seconds and then blinks twice. The code is repeated 3 times. This code sequence will repeat as long as there is a grid fault condition.

This code can be caused by any of the following conditions:

- Low Grid Voltage (<Vac Min)
- High Grid Voltage (>Vac Max)
- Low Grid Frequency (< fac Min)
- High Grid Frequency (>fac Max)
- Rapid change in grid frequency or voltage

Check the condition of the grid at the AC terminal blocks within the Sunny Boy. Also inspect the AC disconnect between the Sunny Boy and the grid.



CAUTION!

Have the grid connection to the Sunny Boy checked only by qualified personnel.

**WARNING!**

If opening the Sunny Boy is required, do so only after disconnecting all sources of power and waiting at least 5 minutes.

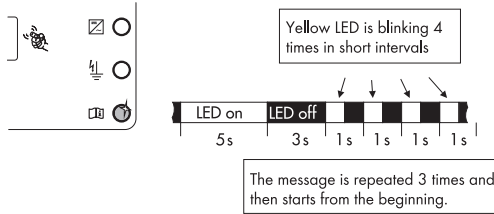
High DC Input Voltage

The yellow LED is on for 5 seconds, remains off for 3 seconds and then blinks 4 times. The code is repeated 3 times. If the condition remains the code will continue to be sent.

The inverter has detected a DC input voltage that is too high for safe operation.

**WARNING!**

Disconnect the PV array from the Sunny Boy immediately. High DC input voltage can permanently damage the inverter. Have the input source checked by a qualified technician.

**WARNING!**

Always test the DC voltage at the DC disconnect switch before energizing the Sunny Boy.

Inverter Fault

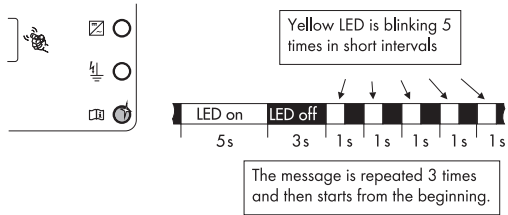

The yellow LED is on for 5 seconds, remains off for 3 seconds and then blinks 5 times. The code is repeated 3 times. If the condition remains the code will continue to be sent.

The inverter has encountered an internal fault that prohibits normal operation and will most likely require servicing.

Contact SMA America for assistance.

7.3 Status Messages on the LCD Display

The Sunny Boy comes standard with the “Sunny Display” LCD in the lid.

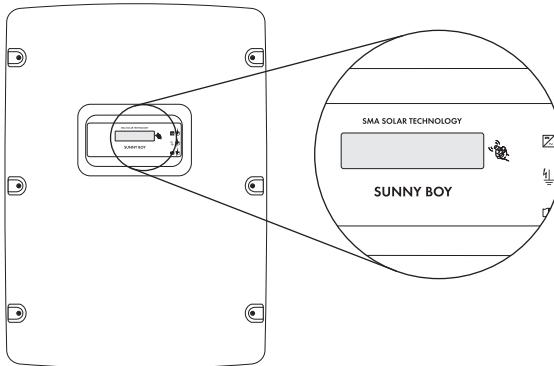

Activation of the Backlight

The backlight is activated by knocking twice on the lid. Additional knocks will scroll through the display messages.

The backlight shuts off automatically after 2 minutes.

INIT Messages

The following messages are displayed during initialization of the inverter:

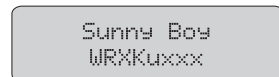

The installed firmware versions of the control system processor (BFR) and the current regulator processor (SRR) are displayed after 6 seconds.

```
BFR Version x.xx.
SRR Version x.xx
```

Operation Messages

The LCD continuously scrolls through all relevant operating data. Each message (MSG) is displayed for 5 seconds, after all messages have been displayed the LCD repeats from the beginning.

MSG #1 "E-Today" (total energy produced on this day) is displayed together with the current operating mode:

```
E-today 8.86kWh
Mode MPP
```

MSG #2 Nominal grid voltage configuration and actual line-to-neutral voltage measurements:

```
Gridtype - 208V
L1 120V L2 120V
```

The Sunny Boy 8000US may not be connected to a 208 V grid.

MSG #3 Actual AC power output and DC input voltage:

```
Pac      500W
Vpv      380V
```

MSG #4 Accumulated energy yield of the device since installation and the total operating hours:

```
E-Total 724.4kWh
h-total  512h
```



The screens may also be scrolled through manually by repeatedly knocking on the lid of the inverter. Each knock advances the screen to the next message.

Fault Messages

In case of a fault condition the LCD switches to "Fault" mode and the backlight is activated.

The upper display line indicates one of the three following failure types:

- Disturbance

For example, this Disturbance message would be displayed if the Sunny Boy detected a problem with the frequency of the utility grid. The message would clear automatically once the condition was corrected. Disturbances are typically caused by a measured value exceeding a predetermined limit.

The display will show the value of the error (at:) as well as the present value for the particular parameter (present:).

```
Disturbance
Fac-Bfr
```

```
at:      59.29Hz
present: 59.30Hz
```

- Warning

For example, this Warning message would be displayed if the GFDI fuse was open or cleared. Typically, Warning messages indicate a system condition that should be investigated. Warning conditions will not preclude inverter operation.



- Error

For example, this Error message would be displayed if the inverter detected a problem with the internal ROM. An Error condition will prevent the inverter from restarting until the condition is cleared.



Each fault message is displayed for 5 seconds. After 5 seconds, the LCD will once again scroll through its normal operating screens. The fault condition will be included in the series of screens until the condition is cleared.

7.3.1 LCD Display Language Selection

The LCD Display has the ability to display information in one of four different languages. Setting the language is performed by using a pair of slide switches located along the bottom edge of the display PC board. The language choices are: Spanish, English, French and German. Use the diagram and chart below for setting the display.

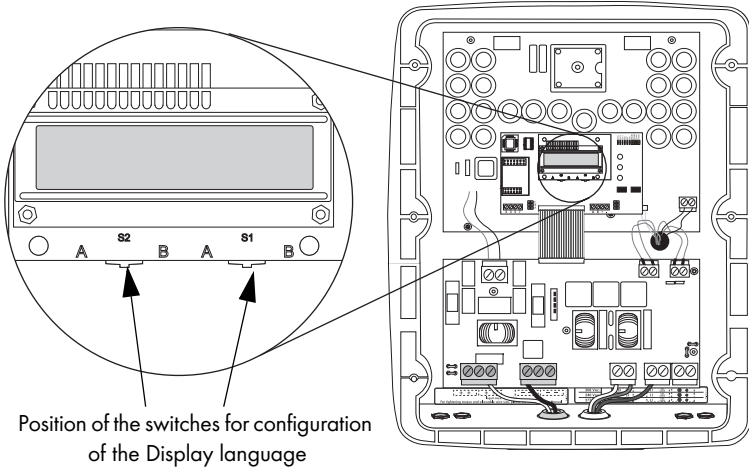

Language Selection Switches for the LCD Display

Language	Switch S2	Switch S1
German	B	B
English	B	A
French	A	B
Spanish	A	A

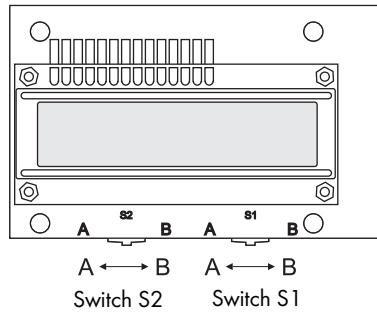

7.4 Measuring Channels and Parameters

The communication options support a number of measuring channels and messages from the Sunny Boy inverters.

The following abbreviations are used:

BFR Betriebsführungsrechner (Sequential Control System)

SRR Stromregelungsrechner (Current Control System)

The BFR and SRR are redundant processor control systems for the utility protection functions.

7.4.1 Measuring Channels

Vpv:	PV input voltage
Vpv Setpoint:	MPPT DC voltage target
Iac:	Grid current
Vac:	Grid voltage L1 - L2
Vac L1:	Grid voltage L1 - N
Vac L2:	Grid voltage L2 - N
Fac:	Grid frequency
Pac:	Power fed to grid
Vpv-PE:	PV-voltage to earth (For troubleshooting PV ground faults)
Temperature:	Temperature measured at IGBT module
Ipv:	PV current
Max Temperature:	Max temperature measured at IGBT
Max Vpv:	Max PV input voltage
I-dif:	Error current
Vfan:	Fan voltage
E-Total:	Total energy yield
h-Total:	Total operation hours
h-on:	h-on indicates how long sufficient DC voltage has been applied to the Sunny Boy and the Sunny Boy has been active including the time it was not able to feed to the utility with respect to low DC voltage or operation in stop mode.
Power On:	Total system start-up counter
Event-Cnt:	Event counter
Serial Number:	Serial number of the Sunny Boy
CO2 saved:	Amount CO2 saved in operation time
Mode:	Current operating mode
Grid Type:	Type of grid the Sunny Boy is connected to
Error:	Description of fault

7.4.2 Operating Mode

Stop:	Manual system stop
Offset:	Offset calibration of the electronics (at start-up)
Waiting:	PV voltage is not high enough to start
Grid monitoring:	Synchronizing to grid (at start-up)
MPP-Search:	MPPT range test (at start-up)
MPP:	Sunny Boy is in MPP mode (normal operation)
V-Const:	Sunny Boy is in constant voltage MPP mode
Derating:	Reduction of the grid feeding power due to abnormal heatsink temperatures
Disturbance:	Grid related fault condition, self clearing
Error:	Inverter fault, user interaction required
Warning:	System warning advising further investigation

7.4.3 Sunny Boy Operating Parameters



CAUTION!

The changing of operating parameters should only be performed by qualified personnel. Changes to factory preset parameters may adversely effect inverter operation and performances.

Modifications of parameters marked with * may result in changes to conformity with IEEE 1547 and should be approved by the local utility and/or authority.

Table 7-1: Operating Parameters of the Sunny Boy

Name	Unit	Range	Default	Password Level	Description
Antiland-Ampl*	deg	0 ... 10	0	Installer	Amplification of the Anti Island process
Antiland-Freq*	mHz	0 ... 2000	500	Installer	Repetition rate of the Anti Island process
CO2-Fact	lbs/kWh	0 ... 2	1.7	Installer	The Sunny Boy evaluates the yield and indicates the approximate CO2 emission avoided by your Sunny Boy. The amount of CO2 avoided is computed according to the kWh produced (E-total) multiplied by the factor defined in the parameter "CO2".
Default		USA/UL1741/ 2005, OFF_Grid, NON IEEE1547	USA/ UL1741/ 2005	Installer	Used for adjusting the parameters country specific settings. Note: After changing one of the parameteres marked with "**", the parameter "default" changes to "adjusted" automatically.

Name	Unit	Range	Default	Password Level	Description
dFac-MAX*	Hz/s	0.005 ... 4	0.5 (for country setting USA/UL1741/2005)	Installer	Maximum "rate of frequency change" before anti-islanding protection engages
E_Total	kWh	0 ... 200000	0	Installer	Total energy yield of the inverter. Changing the value can be necessary when a Sunny Boy is exchanged and you wish to match the previously acquired data.
Fac-delta-*	Hz	0.2 ... 3	0.69 (for country setting USA/UL1741/2005)	Installer	Maximum allowable operating frequency above and below 60 Hz. Default value is optimal for installations < 30 kW.
Fac-delta+*	Hz	0 ... 4.5	0.49 (for country setting USA/UL1741/2005)	Installer	
Fac-MinTripTime*	s	0.16 ... 300	0.16	Installer	Utility interconnection frequency trip time. Default value is optimal for installations < 30 kW.
Fan-Test		1 / 0	0	Installer	By setting this parameter to "1" you can check the function of the fans. This test turns the fans at maximum speed.
h_Total	h	0 ... 200000	0	Installer	Total operating hours of the inverter. Changing the value can be necessary when a Sunny Boy is exchanged and you wish to match the previously acquired data.
Memory Function		no function, Default param., Reset Op.Data, Reset errors	no function	Installer	Default param.: Sets all parameters to default. Reset Op.Data: Sets all parameters that are visible in user level to default values. Reset errors: Resets all permanent device disable errors.
Operating Mode		MPP-Operation, Turbine, V-const, Stop	MPP	Installer	Operating Modes of the Sunny Boy: MPP-Operation: Sets the Sunny Boy in Maximum Power Point Tracking Mode V-const: Constant Voltage Mode (Setpoint defined in "Vconst-Setval") Turbine: Operating mode for wind power plants Stop: Disconnection from utility, no operation
T-Max-Fan	°C	0 ... 100	90	Installer	Temperature for maximum fan rotation speed.

Name	Unit	Range	Default	Password Level	Description
T-Start	s	5 ... 1600	10	Installer	The time the inverter waits to connect to the grid after V _{pv} -Start is exceeded. This value defaults to 5 minutes after a utility fault.
T-Start-Fan	°C	0 ... 100	70	Installer	Fan turn-on temperature at minimum rotating speed.
T-Stop	s	1 ... 1800	2	Installer	The time that the Sunny Boy waits to disconnect from the grid when Pac falls below minimum necessary V _{pv} .
T-Stop-Fan	°C	0 ... 100	55	Installer	Fan turn-off temperature
V-Const Setval	V	SB 5000US - SB 7000US: 250 ... 600 SB 8000US: 300 ... 600	600	Installer	PV Setpoint voltage for constant voltage operation. These parameters only are important in case the parameter "Operating Mode" is set to "V-const".
Vac-Min*	%	0 ... 50	12	Installer	Values are used to calculate the lower limit of allowable AC voltage. Default value is optimal for installations < 30 kW. The default 12 results in a trip value of 88 % as listed under trip limits.
Vac-Max*	%	0 ... 20	10	Installer	Values are used to calculate the upper limit of allowable AC voltage. Default value is optimal for installations < 30 kW. The default 10 results in a trip value of 110 % as listed under trip limits.
Vac-Min-Fast*	%	0 ... 50	50	Installer	Values are used to calculate the lower limit of allowable AC voltage for fast disconnection. Default value is optimal for installations < 30 kW. The default 50 results in a trip value of 50 % as listed under trip limits.
Vac-Max-Fast*	%	0 ... 20	20	Installer	Values are used to calculate the upper limit of allowable AC voltage for fast disconnection. Default value is optimal for installations < 30 kW. The default 20 results in a trip value of 120 % as listed under trip limits.
Vac-Min-Reconnect	%	0 ... 50	11.7	Installer	Values are used to calculate the lower and upper limits to reconnect to the grid after a grid failure.
Vac-Max-Reconnect	%	0 ... 20	5.83	Installer	
V _{pv} -Start	V	SB 5000US - SB 7000US: 250 ... 600 SB 8000US: 300 ... 600	SB 5000US - SB 7000US: 300 SB 8000US: 365	Installer	Minimum DC voltage for the Sunny Boy to connect to the grid.

The following parameters appear in parameter list but cannot be modified:

Table 7-2: Operating Parameters of the Sunny Boy (Fixed)

Name	Unit	Range	Default	Description
P _{limit}	W	fixed	SB5000US: 5100 SB6000US: 6100 SB7000US: 7100 SB8000US: 8100	Upper limit of AC output power
SMA-SN				Serial Number of the Sunny Boy
Software-BFR				Firmware version of the operation control unit (BFR)
Software-SRR				Firmware version of the current control unit (SRR)

8 Troubleshooting

8.1 General

Our quality control program assures that each inverter is manufactured to exact specifications and is thoroughly tested before leaving the factory. If you encounter difficulty with the operation of your inverter, please follow the steps below in an effort to correct the problem.

- Check the blinking code on the lid of the Sunny Boy and compare the code with the blinking codes in Section 6 "Commissioning" (page 69).
- Check and record the exact "Mode" and/or "Error" messages on the LCD display or other communication system available. Take appropriate action to correct the issue.
- If necessary, check the DC and AC voltages at terminals inside the inverter. Be sure to observe all of the safety precautions listed throughout this manual when doing so, or hire a qualified professional.
- If the system problem persists, contact SMA America technical support at: (916)625-0870.

In order to better assist you when contacting SMA America, please provide the following information. This information is required for service assistance.

Information Regarding the Sunny Boy:

- Serial number
- Model Number
- Short description of the problem
- Blinking Code or display message
- What error code is indicated? (Provided a communication option is installed)
- AC line voltage
- DC line voltage
- Check GFDI Fuse
- Can you reproduce the failure? If yes, how?
- Has this problem occurred in the past?
- What were the ambient conditions when the problem occurred?

Information Regarding the PV modules:

- Manufacturer name and model number of the PV module
- Output power of the module
- Open circuit voltage (Voc) of the module
- Number of modules in each string

If it becomes necessary to send the Sunny Boy back to the manufacturer for service, please ship it in the original box to avoid damage during shipping.

8.2 Error Messages

If a fault occurs, the Sunny Boy generates an error code according to the operating mode and the detected fault.

Error Type	Error Code	Description
Disturbance	Bfr-Srr	Communication between micro-controllers is failing
Warning	Derating	The inverter reduces the output power due to high internal temperature.
Error	EarthCurMax-B	BFR-earth current between PV+ and GND is out of tolerable range
Error	EarthCurMax-S	SRR-earth current between PV+ and GND is out of tolerable range
Disturbance	EEPROM	Transition failure during reading or writing of data EEPROM, the data is not essential for safe operation - this failure does not effect performance.
Error	EEPROM p	Data EEPROM defective, device is set to permanent disable due to the fact that the data loss affects important functions of the inverter. Contact SMA.
Disturbance	EeRestore	Internal failure
Disturbance	Fac-Bfr, Fac-Srr	The AC grid frequency is exceeding the allowable range. ("Bfr" or "Srr" is an internal message and is not important to the user.) The Sunny Boy assumes that the public grid is down and disconnects from the grid in order to avoid islanding. If the grid frequency is within the tolerable range and you still observe the failure message "Fac-Bfr" or "Fac-Srr" contact SMA.
Warning	GFDI Fuse Open	The GFDI-Fuse is open or cleared. Check PV array for ground faults before replacing the fuse.
Disturbance	Grid-Timeout, Grid-Fault-S	The type of grid could not be detected (208/240/277 V). In case you are connecting to the 277 V grid, check up if the cables for L1 and N are in the correct position.

Error Type	Error Code	Description
Disturbance	I _{max}	Over current on the AC side. This failure code is indicated in case the current to the AC grid exceeds the specification. This may happen in case of harmful interference on the grid. If you observe "I _{max} " often, check your grid. For assistance contact SMA.
Disturbance	K1-Close	Relay test failed. Contact SMA for assistance.
Error	K1-Open, K2-Open	
Disturbance	MSD-FAC, MSD-Idif	Internal measurement comparison error: The Sunny Boy measured values of BFR and SRR are too different from each other. Contact SMA for assistance.
Error	MSD-VAC	
Disturbance	OFFSET	Grid monitoring self-test failed.
Error	ROM	The internal test of the Sunny Boy control system firmware failed. Contact SMA in case you observe this failure often.
Disturbance	Shut-Down	Internal over current continuous
Disturbance	Vac-Bfr, Vac-Srr	The AC grid voltage is exceeding the allowable range. ("Bfr" or "Srr" is an internal message and is not important for the user.) Vac can also result from a disconnected grid or a disconnected AC cable. The Sunny Boy assumes that the public grid is down and disconnects from the grid in order to avoid islanding. If the grid voltage is within the tolerable range and you still observe the failure message "Vac-Bfr" or "Vac-Srr" contact SMA America.
Disturbance	VacL1-Bfr, VacL2-Bfr, VacL1-Srr, VacL2-Srr	Voltage is too high or too low on the indicated leg.
Disturbance	VpvMax !PV Overvoltage! !Disconnect DC!	DC input voltage above the tolerable maximum value. Disconnect DC immediately!
Disturbance	Watchdog	Watchdog for operation control triggered

Error Type	Error Code	Description
Disturbance	XFMR	<p>Transformer is connected to the wrong grid. Check the connection of the transformer.</p> <p>In Delta corner grounded grids make sure that the Ground of the grid is connected to the terminal L2</p> <p>In unbalanced 208 V and 240 V grids interchanging L1 and L2 may clear this error.</p>
Disturbance	XFMR_TEMP_F	High transformer temperature, the Sunny Boy stops working and the fans work with maximum speed.
Warning	XFMR_TEMP_W	High transformer temperature is gone. The Sunny Boy starts working and shows the failure "XFMR_TEMP_W". Check the function of the fans.

9 Maintenance

The Sunny Boy is designed to provide many years of trouble-free service. Performing regular maintenance will help ensure the long life and high efficiency of your system.

9.1 Cleaning the Fans

The fan intakes and handle covers should be cleaned periodically with a vacuum cleaner. (Do not blow air into the fan areas) For deeper cleanings, the fans can be removed completely.

The Sunny Boy is fitted with two fans on its underside.

In order to clean the fans, proceed as follows:

1. Turn off all DC and AC disconnects and wait for 5 minutes for any residual voltages to dissipate.
2. Disconnect the Sunny Boy from both the DC and AC connections, paying attention to the safety instructions in Section 5 "Wiring the Sunny Boy" (page 36).
3. Wait for the fans to stop rotating.
4. Push the 2 latches at the top of the black plastic cover to one side and remove it carefully with the fan grates mounted behind.
5. The fans themselves are fastened with 3 plastic latches. Unhook the latches and remove the fans by pulling them downwards slowly and carefully. The fan cables are long enough that you can move the fans far enough out to disconnect the internal plug in the Sunny Boy. To do so, unlock the corresponding plugs and remove them. You can now take out the fans and clean them.
6. To clean the fans use a soft brush or cloth. Do not use air pressure for cleaning the fans. This will damage the fans.
7. When the fans are clean, reinstall them using the above steps in reverse order.
8. Do not blow air through the fans or the fan screens while the fan plate is assembled on the Sunny Boy.

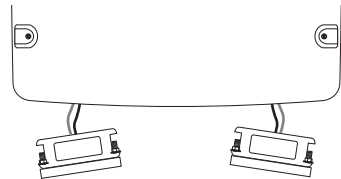
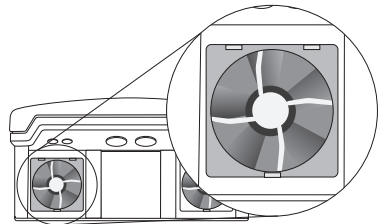

9.2 Cleaning the Handle Covers

There are handle covers on either side of the Sunny Boy. The Sunny Boy sucks air in from underneath via the fan and blows it out again on the upper sides. For optimum heat dissipation within the device, you have to clean both handle covers. Proceed as follows when cleaning the handle covers:

- The handle covers of the Sunny Boy are on the sides of the enclosure. Place your fingers in the space between the top of the housing and the handle covers and gently pull the handle covers out of their bracket.

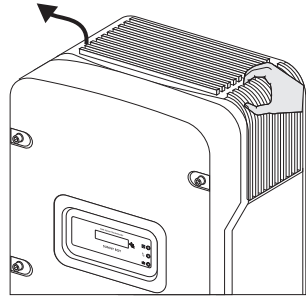

- Insert the handle covers back into the Sunny Boy. The handle covers can only be inserted on the right or left side of the Sunny Boy respectively. "links/left" or "rechts/right" is printed on the inside of the handle covers to help you identify the sides.



The handle covers must not be removed permanently, because otherwise the device is not protected against the entrance of insects! Should the handle covers break, new handle covers can be ordered from SMA America.

9.3 Testing the Fans

You can verify the operation of the fans in two ways:

- Set the parameter "Fan Test" to "1" (with Sunny Data, Sunny Data Control or with the data logger Sunny Boy Control).
- or
- Turn off the inverter by turning off all DC and AC disconnects and wait 5 minutes for any residual voltages to dissipate.
- Once the LED's are off, remove the cover and set the jumpers as shown in the figure below.
- Turn on the inverter by turning on the AC disconnect and then the DC disconnect or switch the SMA DC-Disconnect to the "1" position.

Jumper Position for Fan Test

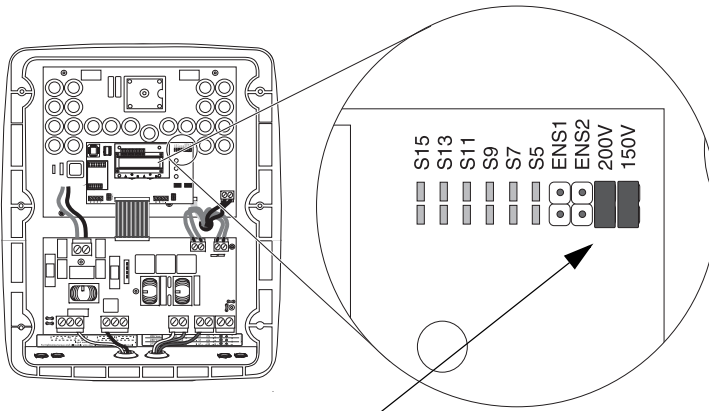

Jumper Position for verifying the operation of the fans

9.4 Exchanging the Fuses

9.4.1 Exchanging the GFDI Fuse within the Sunny Boy

1. Turn OFF all AC and DC switches and/or breakers.
2. Wait for at least 5 minutes.
3. Open the Sunny Boy as described in section 3.1 "Opening the Sunny Boy" (page 18).
4. Exchange the fuse.

For correct fuse location please refer to section "DC Input Grounding" on page 56.

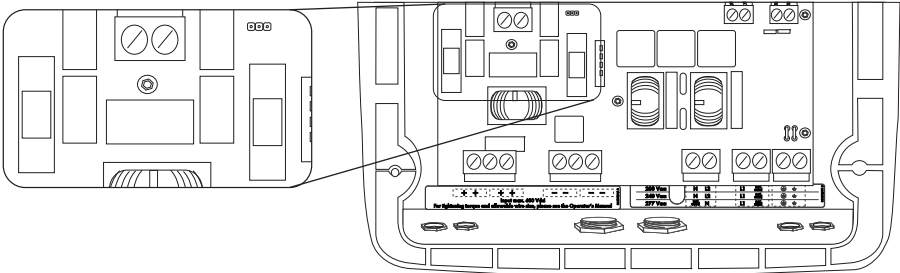

WARNING!

For continued protection against risk of fire, replace only with the same type and ratings of fuse (600 VDC, 1 A)!



Ensure that the fuse is completely inserted in the clamp.

5. Close the Sunny Boy.
6. Turn ON all AC and DC switches and/or breakers.

9.4.2 Exchanging the PV String Fuses within the SMA DC-Disconnect

1. Turn OFF all AC and DC switches and/or breakers.
2. Wait for at least 5 minutes.
3. Open the SMA DC-Disconnect as described in section 5.4 "Opening the SMA DC-Disconnect (if applicable)" (page 41).
4. Exchange the fuses having regard to the information on the next page.

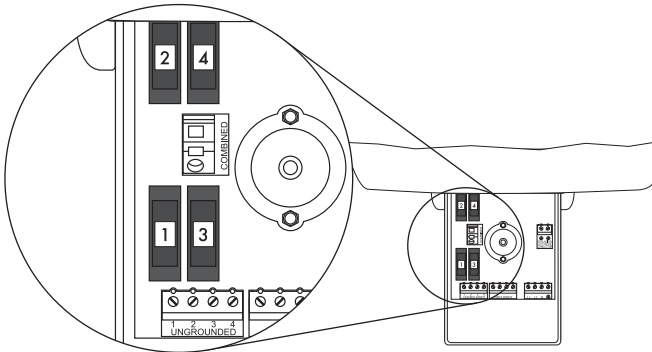

5. Close the SMA DC-Disconnect.
6. Turn ON all AC and DC switches and/or breakers.

PV String Fuse Sizing

In any electrical system, fuses are used to protect wiring and equipment from excessive currents that can cause damage, heating or in extreme cases even fire. If the fuse rating is too small it could open during normal operation. If the fuse rating is too large, it cannot provide the needed protection. In PV systems, the minimum and maximum size of the series fuse is determined by the electrical ratings of the PV module as well as by UL and National Electrical Code (NEC) requirements. Be sure to consult with your PV module manufacturer for appropriate PV string fuse ratings.

The minimum size of fuses and wiring are calculated using the Short Circuit Current Rating (Isc) of the PV module. The NEC requires that all fuses and wiring be sized for a minimum of 1.56 times the Isc of the PV module used in the system. The proper size PV string fuse is determined by calculating $1.56 \times I_{sc}$ (of the PV module) and then rounding up to the next standard fuse size.



If the Isc of the PV module equals 6.9 A DC, then the PV string fuse size is determined by $1.56 \times 6.9 = 10.76$. The next standard fuse size would be a 12 A, 600 V DC fuse.



CAUTION!

The string fuse size must not be greater than the maximum fuse size rating of the PV module as provided on the PV module manufacturers data sheet. If no maximum fuse size is indicated, please contact the PV module manufacturer!

DC Disconnect Requirements

NEC 690.15-18 allows the use of fuse holders as a suitable means of disconnecting PV arrays for servicing. Additional DC disconnects external to the inverter may be required by the local authority having jurisdiction.



WARNING!

Never remove a fuse while it is under load. Electrical arcing and damage to the fuse holder will occur if a fuse is removed under load.

PV String Fuses

The SMA DC-Disconnect is shipped with 15 A, 600 V DC fuses in the fuse holders. The maximum string fuse rating for the SMA DC-Disconnect is 20 A. The figure in chapter 9.4.2 "Exchanging the PV String Fuses within the SMA DC-Disconnect" (page 94) shows the string fuse holders and their corresponding terminals.

10 Technical Specifications

10.1 FCC Compliance Information

SMA Utility Interactive Inverter, Model Sunny Boy

This device complies with Part 15 of the FCC Rules. Operation is subject to the following conditions:

- (1) This device may not cause harmful interference, and
- (2) this device must accept any interference received, including interference that may cause undesired operation.

NOTE: This equipment has been tested and found to comply with the limits for a Class A & B digital device, pursuant to Part 15 of the FCC Rules. These limits are designed to provide reasonable protection against harmful interference in a residential installation. This equipment generates, uses, and can radiate radio frequency energy and if not installed and used in accordance with the instructions, may cause harmful interference to radio communications. However, there is no guarantee that interference will not occur in a particular installation. If this equipment does cause harmful interference to radio or television reception, which can be determined by turning the equipment off and on, the user is encouraged to try to correct the interference by one or more of the following measures:

- Reorient or relocate the receiving antenna.
- Increase the separation between the equipment and the receiver.
- Connect the equipment into an outlet on a circuit different from that to which the receiver is connected.
- Consult the dealer or an experienced radio/TV technician for help.
- The user is cautioned that changes or modifications not expressly approved by SMA America, Inc. could void the user's authority to operate this equipment.

Contact SMA America for more information.

SMA America, Incorporated
4031 Alvis Court
Rocklin, CA 95677
Tel. +1 916 625 0870
Fax +1 916 625 0871
www.SMA-America.com

10.2 Sunny Boy Wiring Diagrams

10.2.1 Without SMA DC-Disconnect

Sunny Boy Connections for 208 and 240 V AC grids

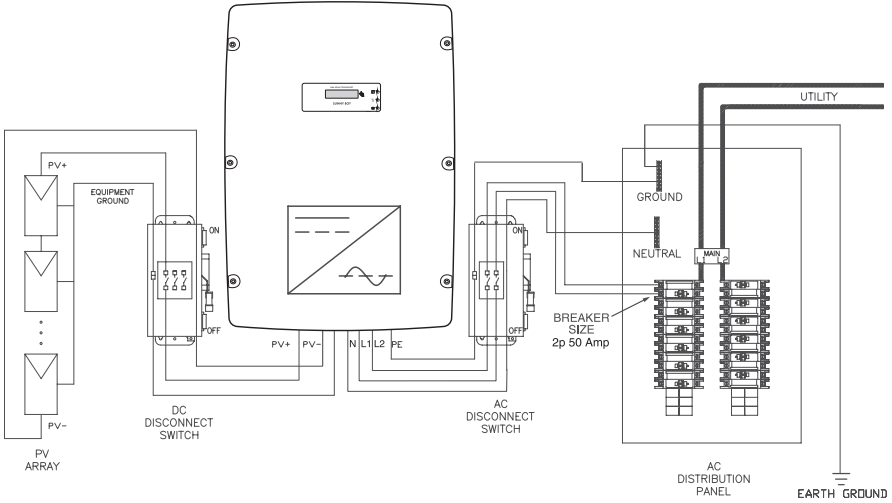

Sunny Boy Connections for 277 V AC grids

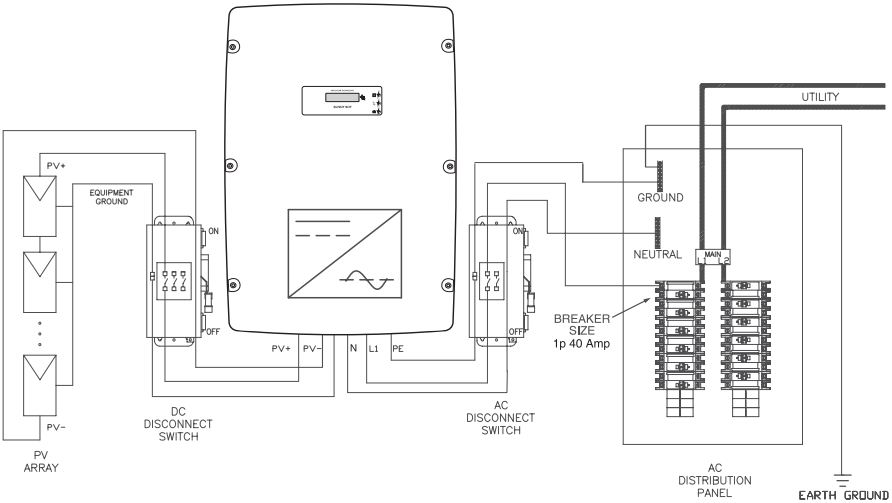

10.2.2 With SMA DC-Disconnect

Sunny Boy Connections for 208 and 240 V AC grids

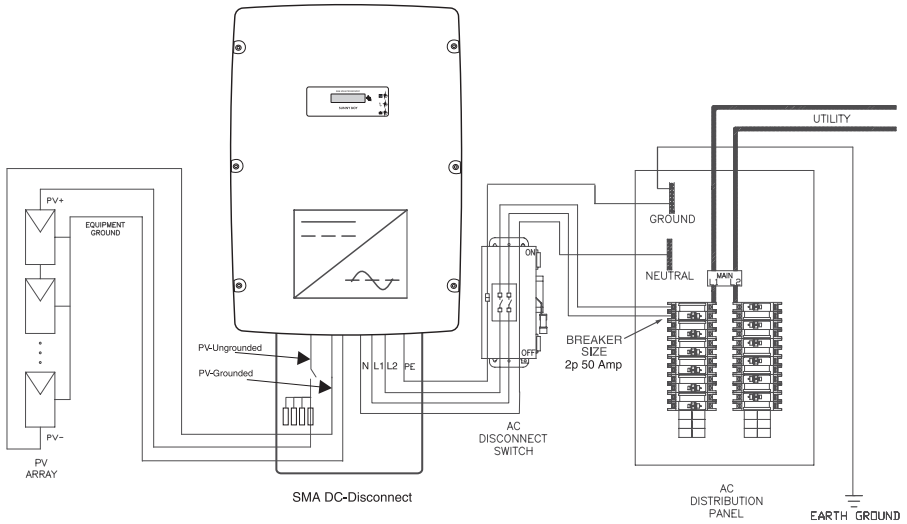

Sunny Boy Connections for 277 V AC grids

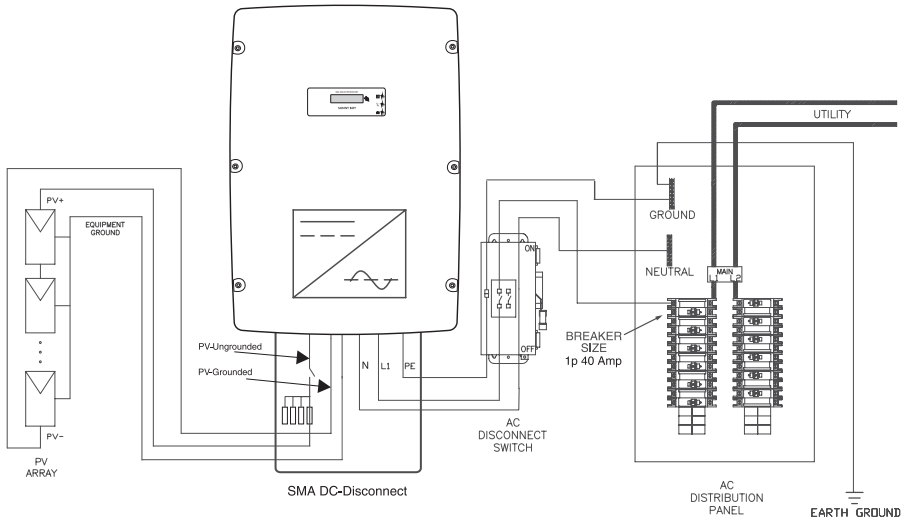

10.3 Specifications

10.3.1 Sunny Boy 5000US and Sunny Boy 6000US

	SB 5000US	SB 6000US
Inverter Technology	True sine wave, low frequency transformer	
AC Operating Voltage Range	183 - 229 (208 V nominal) 211 - 264 (240 V nominal) 244 - 305 (277 V nominal)	
AC Operating Frequency Range	59.3 - 60.5 (60 Hz nominal)	
Peak Power Tracking Voltage	250 - 480 V DC	
Range of Input Operating Voltage	250 - 600 V DC	
Maximum DC Power	5300 W	6400 W
Maximum Array Input Power (DC @ STC)	6250 W	7500 W
Maximum AC Continuous Output Power	5000 W	6000 W
Current THD	Less than 4 %	
Output Power Factor	0.95 - 1.0 (0.99 @ nominal conditions)	
Peak Inverter Efficiency	96.8 %	97.0 %
CEC weighted efficiency	95.5 %	95.5 % @ 208 V AC 95.5 % @ 240 V AC 96.0 % @ 277 V AC
Cooling	OptiCool, forced active cooling	
PV Start Voltage	300 V DC	
Maximum AC Continuous Output Current	208 V = 24 A 240 V = 20.8 A 277 V = 18A	208 V = 29 A 240 V = 25 A 277 V = 21.6 A
Maximum DC Input Current	21 A 25 A	
Maximum input short circuit current	36 A	
Maximum utility backfeed current to PV array	50 A AC	

	SB 5000US	SB 6000US
Maximum Output Fault Current	57.6 A	
Maximum Output Overcurrent Protection	50 A	
Synchronization In-Rush Current	9.23 A	
Trip Limit Accuracy	± 2 %	
Trip Time Accuracy	± 0.1 %	
DC Voltage Ripple	Less than 10 %	
Power Consumption	0.1 W nighttime, < 7 W in operation	
Ambient Temperature Rating	-13 °F to +113 °F (-25 °C to + 45 °C)	
Noise emission, typical	44 dB(A)	45 dB(A)
Enclosure	Diecast aluminum NEMA 3R. (IP54)	
Dimensions	18.42 W x 24.14 H x 9.53 D inches (468 W x 613 H x 242 D mm)	
Weight	147 lbs. (67 kg)	
Compliance	UL1741, UL 1998, IEEE 1547, IEEE 929, IEEE C37.90.1, IEEE C62.41.2 (test conditions 2 kV / 1 kA), FCC Part 15 A & B	

Specifications subject to change without notice.

Values at nominal conditions.

10.3.2 Sunny Boy 7000US and Sunny Boy 8000US

	SB 7000US	SB 8000US
Inverter Technology	True sine wave, low frequency transformer	
AC Operating Voltage Range	183 - 229 (208 V nominal) 211 - 264 (240 V nominal) 244 - 305 (277 V nominal)	211 - 264 (240 V nominal) 244 - 305 (277 V nominal)
AC Operating Frequency Range	59.3 - 60.5 (60 Hz nominal)	
Peak Power Tracking Voltage	250 - 480 V DC	300 - 480 V DC
Range of Input Operating Voltage	250 - 600 V DC	300 - 600 V DC
Maximum DC Power	7500 W	8600 W
Maximum Array Input Power (DC @ STC)	8750 W	10000 W

	SB 7000US	SB 8000US
Maximum AC Continuous Output Power	7000 W	8000 W
Current THD	Less than 4 %	
Output Power Factor	0.95 - 1.0 (0.99 @ nominal conditions)	
Peak Inverter Efficiency	97.1 %	96.5 %
CEC weighted efficiency	95.5 % at 208 V AC 96.0 % at 240 V AC 96.0 % at 277 V AC	96.0 % at 240 V AC 96.0 % at 277 V AC
Cooling	OptiCool, forced active cooling	
PV Start Voltage	300 V DC	365 V DC
Maximum AC Continuous Output Current	208 V = 34 A 240 V = 29 A 277 V = 25.3 A	240 V = 32 A 277 V = 29 A
Maximum DC Input Current	30 A	
Maximum input short circuit current	36 A	
Maximum utility backfeed current to PV array	50 A AC	
Maximum Output Fault Current	57.6 A	61.7 A 9.6 ms
Maximum Output Overcurrent Protection	50 A	
Synchronization In-Rush Current	9.23 A	14.32 A
Trip Limit Accuracy	± 2 %	
Trip Time Accuracy	± 0.1 %	
DC Voltage Ripple	Less than 10 %	
Power Consumption	0.1 W nighttime, < 7 W in operation	
Ambient Temperature Rating	-13 °F to +113 °F (-25 °C to + 45 °C)	
Noise emission, typical	46 dB(A)	49 dB(A)
Enclosure	Diecast aluminum NEMA 3R. (IP54)	
Dimensions	18.42 W x 24.14 H x 9.53 D inches (468 W x 613 H x 242 D mm)	
Weight	141 lbs. (64 kg)	147 lbs. (67 kg)

	SB 7000US	SB 8000US
Compliance	UL1741, UL 1998, IEEE 1547, IEEE 929, IEEE C37.90.1, IEEE C62.41.2 (test conditions 2 kV / 1 kA), FCC Part 15 A & B	

Specifications subject to change without notice.

Values at nominal conditions.

10.3.3 SMA DC-Disconnect

Maximum DC Input Current	36 A DC
Maximum System Voltage	600 V DC
Maximum String Fuse Rating	20 A DC
Maximum AC Operating Current	40 A AC
Enclosure	3R rated

Specifications subject to change without notice.

10.4 Trip Limits / Trip Times

Nominal Freq. (Hz)	Trip Limit (Hz)	Trip Frequencies (Hz)	Trip Times (s)
60	> 60.5	60.45 - 60.55	max. 0.1602
	< 57.0 - 59.8 (default 59.3)	56.95 - 59.85 (default 59.25 - 59.35)	adjustable 0.16 - 300 (default max. 0.1602)
	< 57.0	56.95 - 57.05	max. 0.1602

Nominal Voltage (V)	Trip Limit	Trip Voltages Line-to-Neutral (V)*	Trip Voltages Line-to-Line (V)*	Trip Times (s)
208	50 %	57.6 - 62.4	99.8 - 108.2	max. 0.1602
	88 %	103.2 - 108.0	178.9 - 187.2	max. 2.002
	110 %	129.6 - 134.4	224.6 - 233.0	max. 1.001
	120 %	141.6 - 146.4	245.4 - 253.8	max. 0.1602
240	50 %	57.6 - 62.4	115.2 - 124.8	max. 0.1602
	88 %	103.2 - 108.0	206.4 - 216.0	max. 2.002
	110 %	129.6 - 134.4	259.2 - 268.8	max. 1.001
	120 %	141.6 - 146.4	283.2 - 292.8	max. 0.1602
277	50 %	133.0 - 144.0	N/A	max. 0.1602
	88 %	238.2 - 249.3		max. 2.002
	110 %	299.2 - 310.2		max. 1.001
	120 %	326.9 - 337.9		max. 0.1602

* The intervals result from the measuring accuracies listed below.

Manufacturer's Accuracies:

Trip Limit Accuracy: $\pm 2\%$ of nominal grid voltage

Trip Time Accuracy: $\pm 0.1\%$ of nominal trip time

Trip Frequency Accuracy: $\pm 0.1\%$ of nominal frequency

10.5 Torque Values and Wire Sizes

Terminal	in. lbs.	Nm.	Wire Size
Grey AC & DC Terminal Blocks (Weidmüller) Inverter	18	2	10 - 6 AWG
Green AC & DC Terminal Blocks (Phoenix) Inverter	40	4.5	8 - 6 AWG
	22	2.5	10 AWG
Grey AC Configuration Terminal Blocks for Unused Wires (Weidmüller)	11	1.2	–
Green AC Configuration Terminal Blocks for Unused Wires (Phoenix)	15	1.7	–
AC & DC Terminal Blocks SMA DC-Disconnect	15	1.7	10 - 6 AWG
Combined Terminal Block SMA DC-Disconnect	Spring Terminal	Spring Terminal	10 - 6 AWG
Grounding Electrode Conductor Terminal Block SMA DC- Disconnect	15	1.7	10 - 6 AWG
Screws for fastening the Sunny Boy and the SMA DC- Disconnect to the wall mounting bracket and closing the SMA DC-Disconnect cover	44	5	–
Cover Screws	53	6	–

SMA America, Incorporated

www.sma-america.com

